

Electrostatic Discharged Protection Devices (ESD) Data Sheet

Description

The series are an ultra low capacitance TVS array designed to protect high speed data interfaces. This series has been specifically designed to protect sensitive components which are connected to data transmission lines from overvoltage caused by electrostatic discharge (ESD), cable discharge events (CDE) and lightning.

The unique design incorporates surge rated, low capacitance steering diodes and a TVS diode in a single package. During transient conditions, the steering diodes direct the transient current to ground. The internal TVS diode clamps the transient voltage to a safe level. The ultra low capacitance array configuration allows the user to protect up to the high speed data lines. These devices are in a signal package, RoHS/WEEE compliant, SOD-323 package. It measures 2.5x1.25x1.0mm.

The series devices may be used to meet the immunity requirements of IEC61000-4-2 (ESD), IEC61000-4-4 (EFT) and IEC61000-4-5 (Surge).



Contact : $\pm 30\text{kV}$
Air : $\pm 30\text{kV}$



Features

- IEC61000-4-2 ESD 30KV Air, 30KV contact compliance
ESD 15KV Air, 8KV contact compliance for UDD32C36L01
- SOD-323 surface mount package
- Protects one I/O line
- Working voltage: 3V, 5V, 8V, 12V, 15V, 24V, 36V
- Low leakage current
- Low operating and clamping voltages
- Solid-state silicon avalanche technology
- Lead Free/RoHS compliant
- Solder reflow temperature: Pure Tin-Sn, 260~270°C
- Flammability rating UL 94V-0
- Meets MSL level 1, per J-STD-020

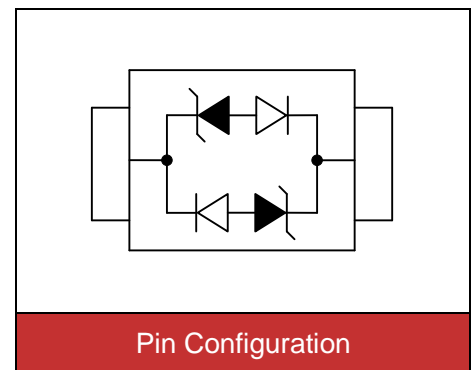

Applications

- USB 2.0 and USB 3.0 interface
- 10/100/1000 Ethernet
- Personal digital assistants (PDA)
- Serial ATA protection
- Digital visual interface (DVI)
- Wireless system devices
- Handhelds and notebooks
- Digital cameras
- RF interface

Maximum Ratings

Rating	Symbol	Value	Unit
Peak pulse power (tp=8/20μs waveform)	P _{PP}	350	W
ESD voltage (Contact discharge)	V _{ESD}	±30	kV
ESD voltage (Air discharge)		±30	
Storage & operating temperature range	T _{STG} , T _J	-55~+150	°C

Electrical Characteristics (T_J=25°C)
UDD32C03L01 (Marking: AC)

Parameter	Symbol	Condition	Min.	Typ.	Max.	Unit
Reverse stand-off voltage	V _{RWM}				3.3	V
Reverse breakdown voltage	V _{BR}	I _{BR} =1mA	4			V
Reverse leakage current	I _R	V _R =3.3V			5	μA
Clamping voltage (tp=8/20μs)	V _C	I _{PP} =1A			7	V
Clamping voltage (tp=8/20μs)	V _C	I _{PP} =5A			15	V
Peak Pulse Current (tp=8/20μs)	I _{PP}				19	A
Off state junction capacitance	C _J	0Vdc, f=1MHz		0.8		pF

UDD32C05L01 (Marking: BC)

Parameter	Symbol	Condition	Min.	Typ.	Max.	Unit
Reverse stand-off voltage	V _{RWM}				5	V
Reverse breakdown voltage	V _{BR}	I _{BR} =1mA	6			V
Reverse leakage current	I _R	V _R =5V			5	μA
Clamping voltage (tp=8/20μs)	V _C	I _{PP} =1A			9.8	V
Clamping voltage (tp=8/20μs)	V _C	I _{PP} =5A			18.3	V
Peak Pulse Current (tp=8/20μs)	I _{PP}				17	A
Off state junction capacitance	C _J	0Vdc, f=1MHz		0.8		pF

UDD32C08L01 (Marking: BC.)

Parameter	Symbol	Condition	Min.	Typ.	Max.	Unit
Reverse stand-off voltage	V _{RWM}				8	V
Reverse breakdown voltage	V _{BR}	I _{BR} =1mA	8.5			V
Reverse leakage current	I _R	V _R =8V			1	μA
Clamping voltage (tp=8/20μs)	V _C	I _{PP} =1A			13	V
Clamping voltage (tp=8/20μs)	V _C	I _{PP} =10A			24	V
Peak Pulse Current (tp=8/20μs)	I _{PP}				17	A
Off state junction capacitance	C _J	0Vdc, f=1MHz		1		pF

UDD32C12L01 (Marking: DC)

Parameter	Symbol	Condition	Min.	Typ.	Max.	Unit
Reverse stand-off voltage	V_{RWM}				12	V
Reverse breakdown voltage	V_{BR}	$I_{BR}=1mA$	13.3			V
Reverse leakage current	I_R	$V_R=12V$			1	μA
Clamping voltage (tp=8/20 μs)	V_C	$I_{PP}=1A$			19	V
Clamping voltage (tp=8/20 μs)	V_C	$I_{PP}=5A$			28.6	V
Peak Pulse Current (tp=8/20 μs)	I_{PP}				7	A
Off state junction capacitance	C_J	0Vdc,f=1MHz		0.8		pF

UDD32C15L01 (Marking: EC)

Parameter	Symbol	Condition	Min.	Typ.	Max.	Unit
Reverse stand-off voltage	V_{RWM}				15	V
Reverse breakdown voltage	V_{BR}	$I_{BR}=1mA$	16.7			V
Reverse leakage current	I_R	$V_R=15V$			1	μA
Clamping voltage (tp=8/20 μs)	V_C	$I_{PP}=1A$			24	V
Clamping voltage (tp=8/20 μs)	V_C	$I_{PP}=5A$			35	V
Peak Pulse Current (tp=8/20 μs)	I_{PP}				6	A
Off state junction capacitance	C_J	0Vdc,f=1MHz		0.8		pF

UDD32C24L01 (Marking: HC)

Parameter	Symbol	Condition	Min.	Typ.	Max.	Unit
Reverse stand-off voltage	V_{RWM}				24	V
Reverse breakdown voltage	V_{BR}	$I_{BR}=1mA$	26.7			V
Reverse leakage current	I_R	$V_R=24V$			1	μA
Clamping voltage (tp=8/20 μs)	V_C	$I_{PP}=1A$			43	V
Clamping voltage (tp=8/20 μs)	V_C	$I_{PP}=5A$			56	V
Peak Pulse Current (tp=8/20 μs)	I_{PP}				6	A
Off state junction capacitance	C_J	0Vdc,f=1MHz		0.8		pF

UDD32C36L01 (Marking: KC)

Parameter	Symbol	Condition	Min.	Typ.	Max.	Unit
Reverse stand-off voltage	V_{RWM}				36	V
Reverse breakdown voltage	V_{BR}	$I_{BR}=1mA$	40			V
Reverse leakage current	I_R	$V_R=36V$			1	μA
Clamping voltage ($t_p=8/20\mu s$)	V_C	$I_{PP}=1A$			70	V
Clamping voltage ($t_p=8/20\mu s$)	V_C	$I_{PP}=2A$			75	V
Peak Pulse Current ($t_p=8/20\mu s$)	I_{PP}				3	A
Off state junction capacitance	C_J	0Vdc, f=1MHz		0.8		pF

Typical Characteristics Curves

Figure 1. Power Derating Curve

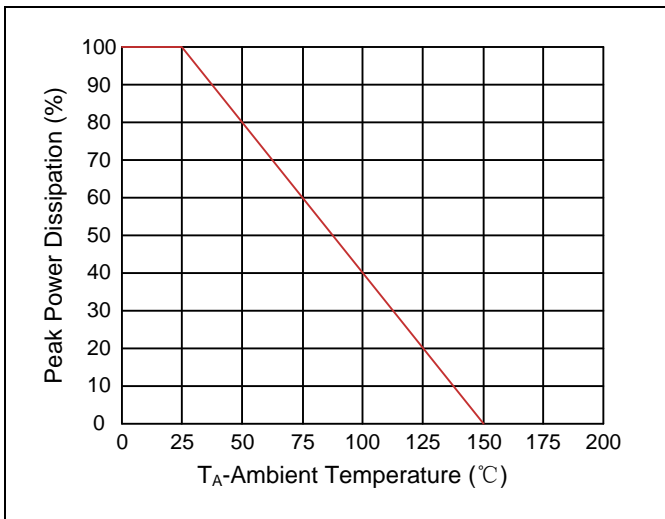

Figure 2. Pulse Waveform

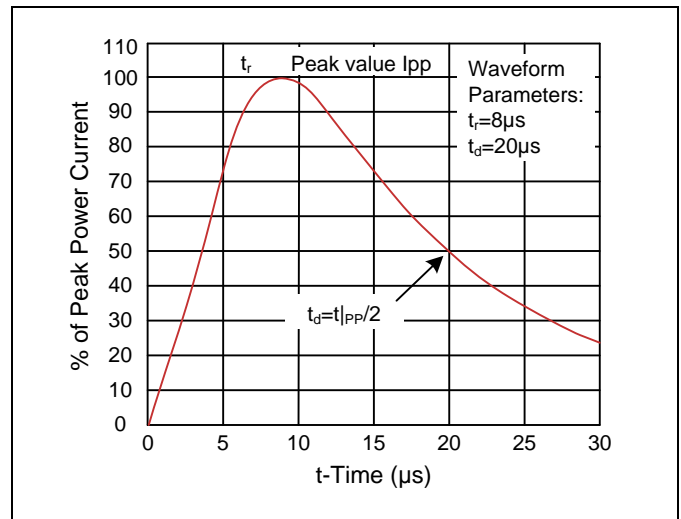

Figure 3. Non-Repetitive Peak Pulse vs Pulse Time

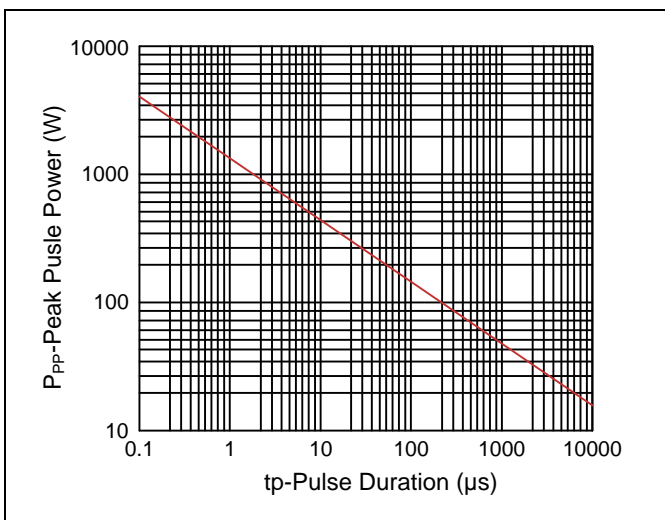
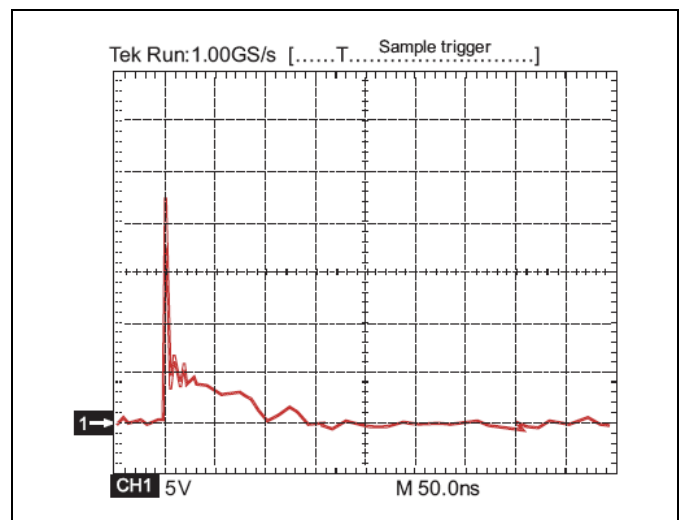
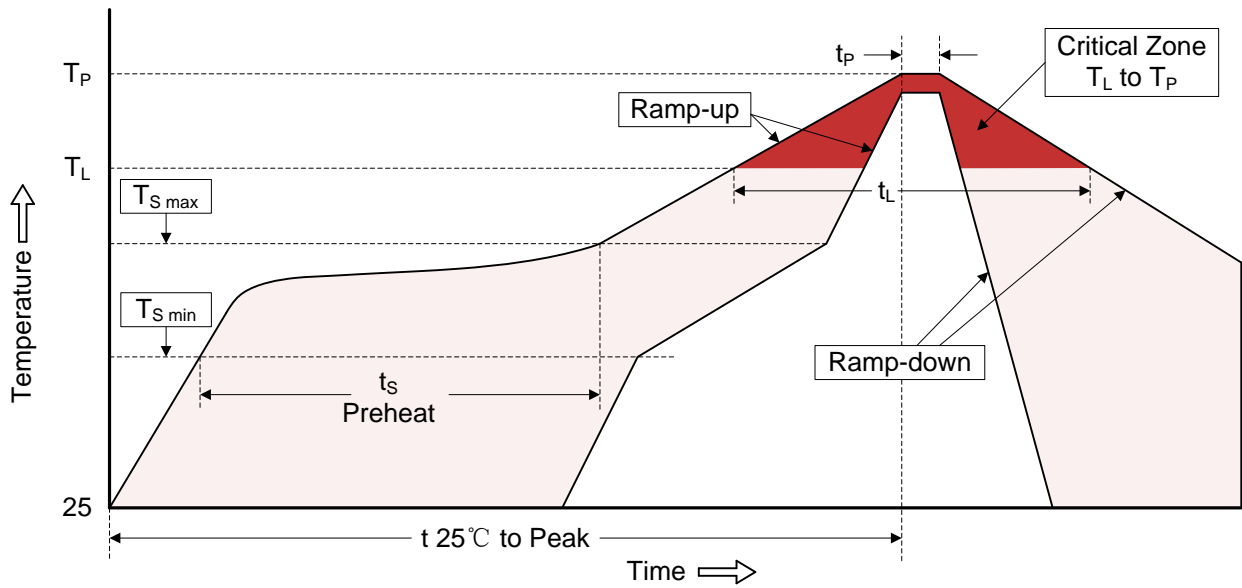

Figure 4. ESD Clamping (8kV Contact IEC61000-4-2)



Recommended Soldering Conditions

Reflow Soldering



Recommended Condition

Profile Feature	Pb-Free Assembly
Average ramp-up rate (T_L to T_P)	3°C/second max.
Preheat -Temperature Min ($T_{S\ min}$) -Temperature Max ($T_{S\ max}$) -Time (min to max) (t_s)	150°C 200°C 60-180 seconds
$T_{S\ max}$ to T_L -Ramp-up Rate	3°C/second max.
Time maintained above: -Temperature (T_L) -Time (t_L)	217°C 60-150 seconds
Peak Temperature (T_P)	260°C
Time within 5°C of actual Peak Temperature (t_P)	20-40 seconds
Ramp-down Rate	6°C/second max.
Time 25°C to Peak Temperature	8 minutes max.

Dimensions (SOD-323)

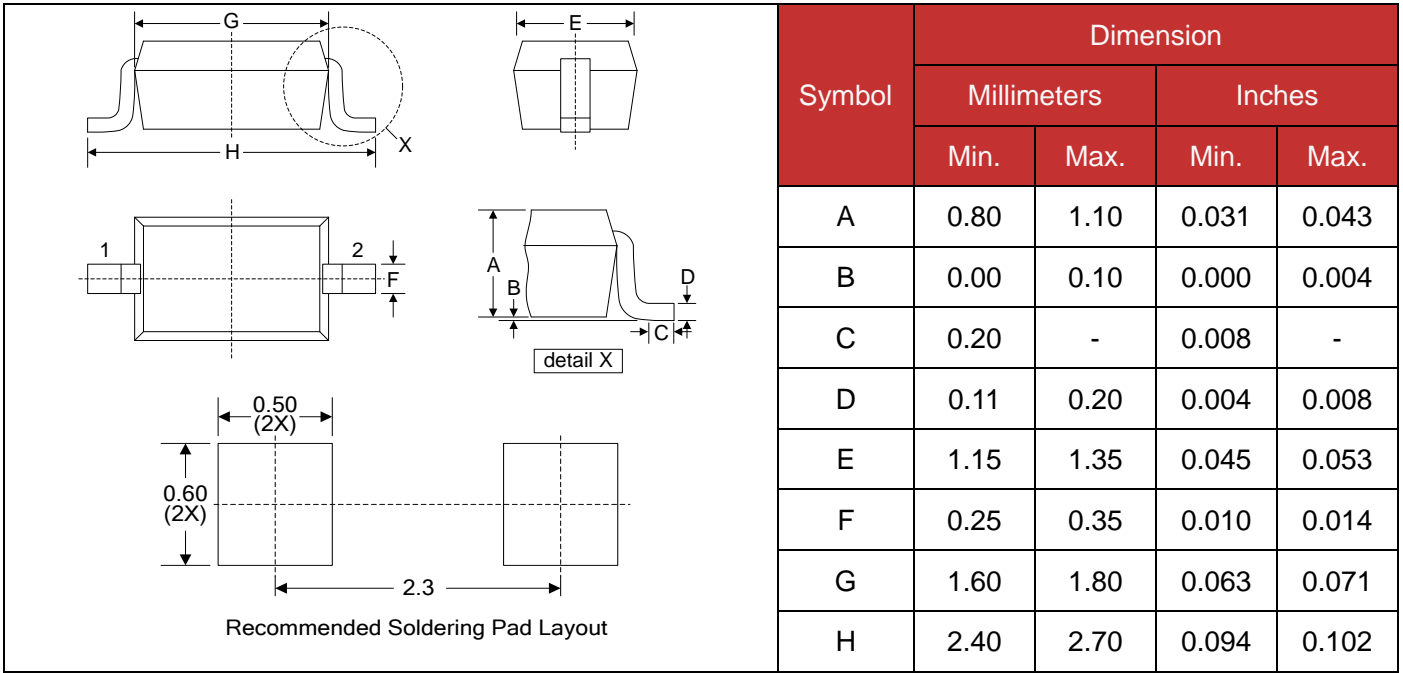

Packaging

