

TCXO/VC-TCXO
HIGH STABILITY



Product Number
TG-5006CJ : X1G004131xxx00
TG-5006CG : X1G004211xxx00
TG-5006CE : X1G004201xxx00

TG-5006CJ / CG / CE

- Frequency range : 13 to 52MHz(TG-5006CJ/CG)
13 to 20MHz, 26 to 40MHz(TG-5006CE)
- Supply voltage : 1.8 V Typ./ 2.8 V Typ./ 3.0 V Typ./ 3.3 V Typ.
- Frequency / temperature characteristics : $\pm 0.5 \times 10^{-6}$ Max or $\pm 2.0 \times 10^{-6}$ Max.
- Applications : GPS, RF,
Wireless communication devices
(CDMA, WCDMA, LTE, WiMAX, other)
- Features : High stability



Specifications (characteristics)

Item	Symbol	VC-TCXO	TCXO	Conditions / Remarks
Output frequency range	fo	16.367667 MHz, 16.368 MHz, 16.369 MHz, 19.2 MHz, 26 MHz and 38.4 MHz		Standard frequency
		13.000 MHz to 52.000 MHz		TG-5006CJ/TG5006CG
		13.000 MHz to 20.000 MHz, 26.000 MHz to 40.000 MHz		TG-5006CE
Supply voltage	Vcc	1.8 V ± 0.1 V / 2.8 V $\pm 5\%$ / 3.0 V $\pm 5\%$ / 3.3 V $\pm 5\%$		Supply voltage range : 1.7 V to 3.465 V
Storage temperature range	T_stg	-40 °C to +90 °C		Storage as single product.
Operating temperature range	T_use	-30 °C to +85 °C		
Frequency tolerance	f_tol	$\pm 2.0 \times 10^{-6}$ Max.		After reflow, +25 °C
Frequency/temperature characteristics	fo-Tc	$\pm 0.5 \times 10^{-6}$ Max. / -30 °C to +85 °C		High stability version for GPS
		$\pm 2.0 \times 10^{-6}$ Max. / -30 °C to +85 °C		Standard stability version
Frequency/load coefficient	fo-Load	$\pm 0.2 \times 10^{-6}$ Max.		10 k Ω // 10 pF $\pm 10\%$
Frequency/voltage coefficient	fo-Vcc	$\pm 0.2 \times 10^{-6}$ Max.		Vcc $\pm 5\%$
Frequency aging	f_age	$\pm 1.0 \times 10^{-6}$ Max.		+25 °C, First year, 13 MHz \leq fo \leq 40 MHz
		$\pm 1.5 \times 10^{-6}$ Max.		+25 °C, First year, 40 MHz < fo \leq 52 MHz
Current consumption	Icc	1.5 mA Max.		13 MHz \leq fo \leq 26 MHz
		2.0 mA Max.		26 MHz < fo \leq 52 MHz
Input impedance	Zin	500 k Ω Min.	—	Vc- GND (DC)
Frequency control range	f_cont	$\pm 8.0 \times 10^{-6}$ to $\pm 15.0 \times 10^{-6}$		Vc = 0.9 V ± 0.6 V (Vcc = 1.8 V) or Vc = 1.4 V ± 1.0 V (Vcc = 2.8 V) or Vc = 1.5 V ± 1.0 V (Vcc = 3.0 V) or Vc = 1.65 V ± 1.0 V (Vcc = 3.3 V)
Frequency change polarity	f_cp	Positive polarity		—
Symmetry	SYM	40 % to 60 %		GND level (DC cut)
Output voltage	Vpp	0.8 V Min.		Peak to Peak
Start-up time	t_str	2.0 ms Max.		T=0 at 90% Vcc
Output load	Load_R	10 k Ω		DC cut capacitor = 0.01 μ F
	Load_C	10 pF		

* Note : Please contact us for requirements not listed in this specification.

Product Name **TG-5006 CJ-*** 19.200000MHz**
 (Standard form) ① ② ③ ④

① Model ② Package type ③ Spec segment (Please contact us) ④ Frequency

External dimensions

(Unit: mm)

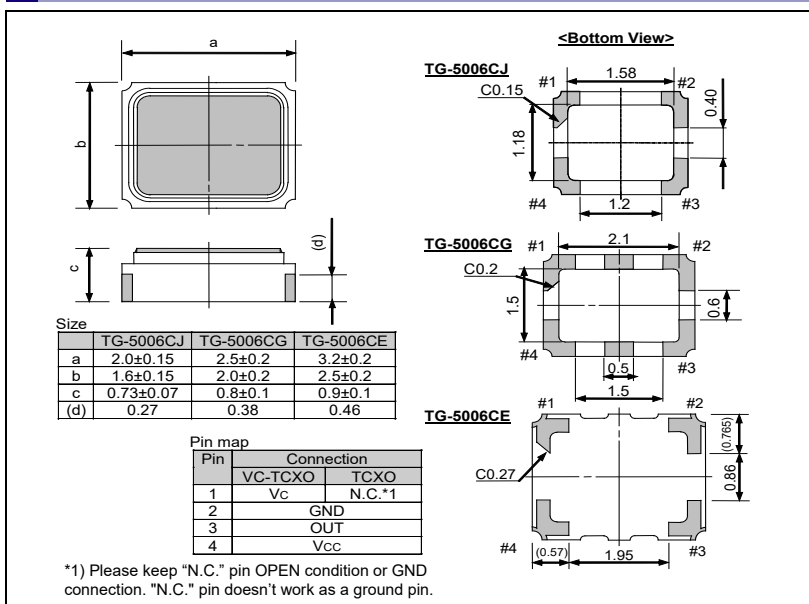

Footprint (Recommended)

(Unit: mm)

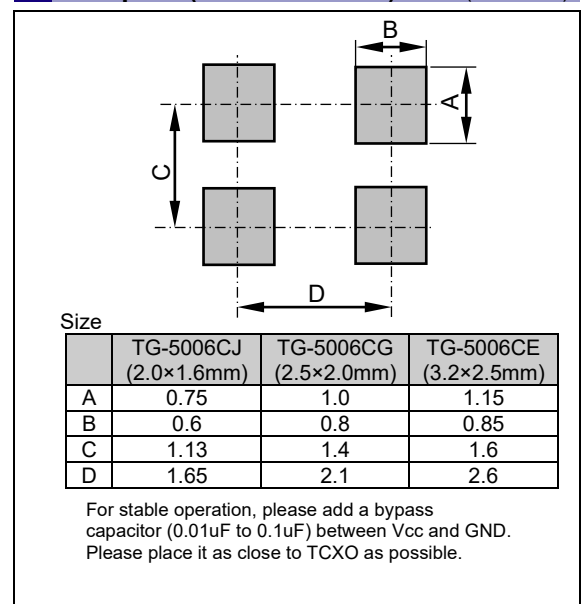

PROMOTION OF ENVIRONMENTAL MANAGEMENT SYSTEM CONFORMING TO INTERNATIONAL STANDARDS

At Seiko Epson, all environmental initiatives operate under the Plan-Do-Check-Action (PDCA) cycle designed to achieve continuous improvements. The environmental management system (EMS) operates under the ISO 14001 environmental management standard.

All of our major manufacturing and non-manufacturing sites, in Japan and overseas, completed the acquisition of ISO 14001 certification.

ISO 14000 is an international standard for environmental management that was established by the International Standards Organization in 1996 against the background of growing concern regarding global warming, destruction of the ozone layer, and global deforestation.

WORKING FOR HIGH QUALITY

In order provide high quality and reliable products and services than meet customer needs, Seiko Epson made early efforts towards obtaining ISO9000 series certification and has acquired ISO9001 for all business establishments in Japan and abroad. We have also acquired IATF 16949 certification that is requested strongly by major automotive manufacturers as standard.

IATF 16949 is the international standard that added the sector-specific supplemental requirements for automotive industry based on ISO9001.

► Explanation of the mark that are using it for the catalog

	► Pb free.
	► Complies with EU RoHS directive. *About the products without the Pb-free mark. Contains Pb in products exempted by EU RoHS directive. (Contains Pb in sealing glass, high melting temperature type solder or other.)
	► Designed for automotive applications such as Car Multimedia, Body Electronics, Remote Keyless Entry etc.
	► Designed for automotive applications related to driving safety (Engine Control Unit, Air Bag, ESC etc).

NOTICE : PLEASE READ CAREFULLY BELOW BEFORE THE USE OF THIS DOCUMENT ©Seiko Epson Corporation 2020

- The content of this document is subject to change without notice. Before purchasing or using Epson products, please contact with sales representative of Seiko Epson Corporation ("Epson") for the latest information and be always sure to check the latest information published on Epson's official web sites and resources.
- This document may not be copied, reproduced, or used for any other purposes, in whole or in part, without Epson's prior consent.
- Information provided in this document including, but not limited to application circuits, programs and usage, is for reference purpose only. Epson makes no guarantees against any infringements or damages to any third parties' intellectual property rights or any other rights resulting from the information. This document does not grant you any licenses, any intellectual property rights or any other rights with respect to Epson products owned by Epson or any third parties.
- Using Epson products, you shall be responsible for safe design in your products; that is, your hardware, software, and/or systems shall be designed enough to prevent any critical harm or damages to life, health or property, even if any malfunction or failure might be caused by Epson products. In designing your products with Epson products, please be sure to check and comply with the latest information regarding Epson products (including, but not limited to this document, specifications, data sheets, manuals, and Epson's web site). Using technical contents such as product data, graphic and chart, and technical information, including programs, algorithms and application circuit examples under this document, you shall evaluate your products thoroughly both in stand-alone basis and within your overall systems. You shall be solely responsible for deciding whether to adopt/use Epson products with your products.
- Epson has prepared this document carefully to be accurate and dependable, but Epson does not guarantee that the information is always accurate and complete. Epson assumes no responsibility for any damages you incurred due to any misinformation in this document.
- No dismantling, analysis, reverse engineering, modification, alteration, adaptation, reproduction, etc., of Epson products is allowed.
- Epson products have been designed, developed and manufactured to be used in general electronic applications and specifically designated applications ("Anticipated Purpose"). Epson products are NOT intended for any use beyond the Anticipated Purpose that requires particular quality or extremely high reliability in order to refrain from causing any malfunction or failure leading to critical harm to life and health, serious property damage, or severe impact on society, including, but not limited to listed below ("Specific Purpose"). Therefore, you are strongly advised to use Epson products only for the Anticipated Purpose. Should you desire to purchase and use Epson products for Specific Purpose, Epson makes no warranty and disclaims with respect to Epson products, whether express or implied, including without limitation any implied warranty of merchantability or fitness for any Specific Purpose. Please be sure to contact our sales representative in advance, if you desire Epson products for Specific Purpose:
Space equipment (artificial satellites, rockets, etc.)/ Transportation vehicles and their control equipment (automobiles, aircraft, trains, ships, etc.) / Medical equipment/ Relay equipment to be placed on sea floor/ Power station control equipment / Disaster or crime prevention equipment/Traffic control equipment/ Financial equipment
Other applications requiring similar levels of reliability as the above
- Epson products listed in this document and our associated technologies shall not be used in any equipment or systems that laws and regulations in Japan or any other countries prohibit to manufacture, use or sell. Furthermore, Epson products and our associated technologies shall not be used for the purposes of military weapons development (e.g. mass destruction weapons), military use, or any other military applications. If exporting Epson products or our associated technologies, please be sure to comply with the Foreign Exchange and Foreign Trade Control Act in Japan, Export Administration Regulations in the U.S.A (EAR) and other export-related laws and regulations in Japan and any other countries and to follow their required procedures.
- Epson assumes no responsibility for any damages (whether direct or indirect) caused by or in relation with your non-compliance with the terms and conditions in this document or for any damages (whether direct or indirect) incurred by any third party that you give, transfer or assign Epson products.
- For more details or other concerns about this document, please contact our sales representative.
- Company names and product names listed in this document are trademarks or registered trademarks of their respective companies.