

EL TOP VIEW LED A09K-UY1501H-AM



Features

- Package : PLCC 6 package
- Color : Yellow
- Typ. Luminance Intensity : 5500 mcd @ 150mA
- Viewing angle : 120°
- ESD : 8KV
- MSL : 2
- Qualified AEC-Q101
- Compliance with RoHS and REACH
- Sulfur robustness

Applications

- Automotive exterior lighting
- Turning signal

Contents

1. Characteristics	3
2. Absolute Maximum Ratings	4
3. Characteristics Graph	5
4. Binning Information	10
5. Part Number.....	13
6. Ordering Information	14
7. Mechanical Dimension.....	15
8. Recommended Soldering Pad.....	16
9. Reflow Soldering Profile.....	16
10. Packaging Information.....	17
11. Precaution for Use	19

1. Characteristics

Parameter	Symbol	Min.	Typ.	Max.	Unit	Condition
Forward Current	I_F	20	150	200	mA	---
Luminous Intensity	I_V	3550	5500	7100	mcd	$I_F=150\text{mA}$
Forward Voltage	V_F	1.75	2.15	2.75	V	$I_F=150\text{mA}$
Viewing Angle	ϕ	---	120	---	deg	$I_F=150\text{mA}$
Dominant Wavelength	λ_d	582	589	594	nm	$I_F=150\text{mA}$
Thermal Resistance (Junction to Solder)	Real	$R_{th JS real}$	---	---	60	K/W $I_F=150\text{mA}$
	Electrical	$R_{th JS el}$	---	---	50	

Notes:

1. Luminous Flux measurement tolerance: $\pm 8\%$.
2. The data of Luminous Flux measured at thermal pad= 25°C
3. Forward voltage measurement tolerance: $\pm 0.05\text{V}$
4. The V_F range shown in the table above indicates 99% output.
5. Tolerance of Dominant Wavelength : $\pm 1\text{nm}$.

2. Absolute Maximum Ratings

Parameter	Symbol	Ratings	Unit
Power Dissipation	P_d	550	mW
Forward Current	I_F	200	mA
Surge Current ($t \leq 10 \mu\text{s}$; $D=0.005$; $T_s=25 \text{ }^\circ\text{C}$)	I_{FM}	1000	mA
Reverse Voltage	V_R	Not designed for reverse operation	V
Junction Temperature	T_J	125	$^\circ\text{C}$
Operating Temperature	T_{opr}	-40 ~ +110	$^\circ\text{C}$
Storage Temperature	T_{stg}	-40 ~ +110	$^\circ\text{C}$
ESD Sensitivity ($R=1.5\text{k}\Omega$, $C=100\text{pF}$)	ESD_{HBM}	8	kV
Soldering Temperature	Reflow	260 $^\circ\text{C}$ for 30sec	$^\circ\text{C}$

3. Characteristics Graph

Wavelength Characteristics Relative Spectral Distribution
@ Ts = 25°C, If=150mA

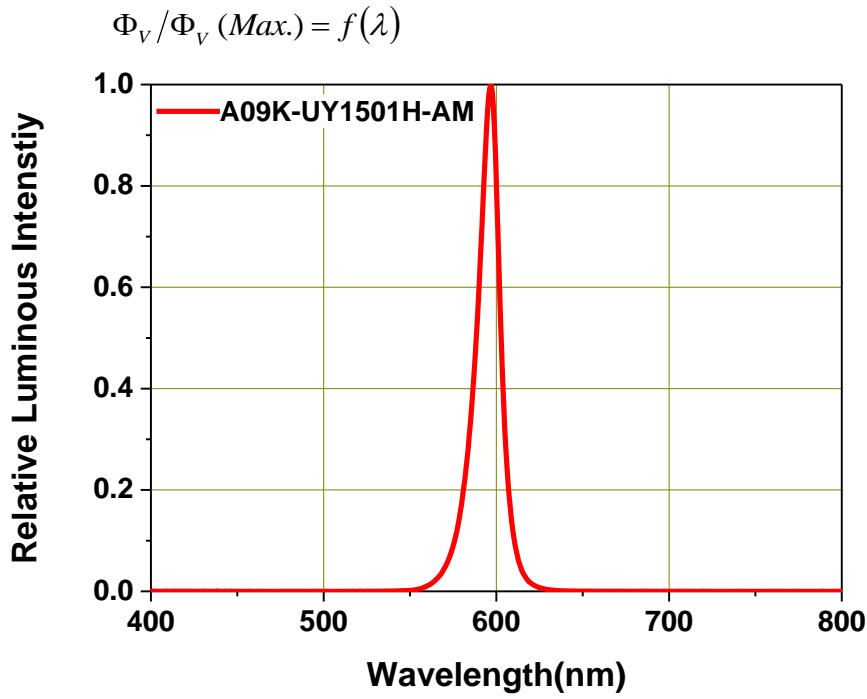

Typical Diagram Characteristics of Radiation

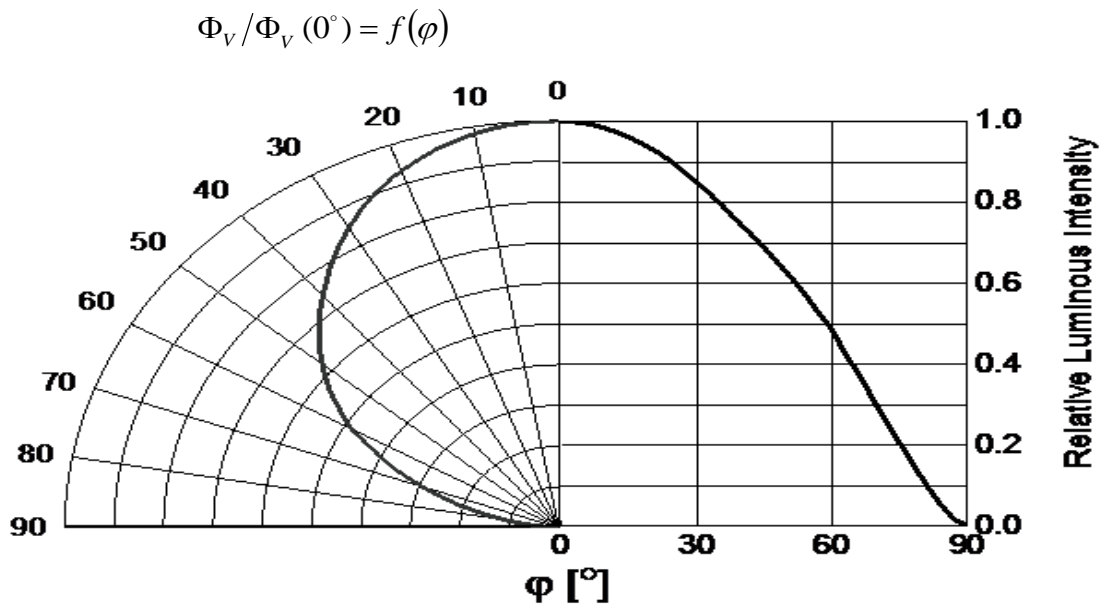

Notes:

1. φ is the off axis angle from lamp centerline where the luminous intensity is 1/2 of the peak value.
2. View angle tolerance is $\pm 5^\circ$.

Forward Current vs. Forward Voltage @ Ts = 25°C

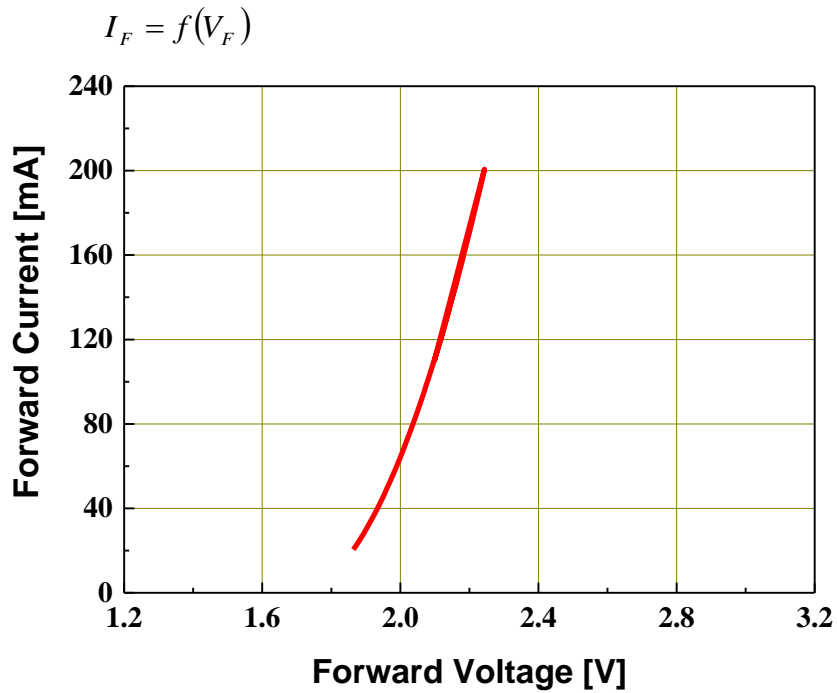

Relative Luminous Intensity vs. Forward Current @ Ts = 25°C

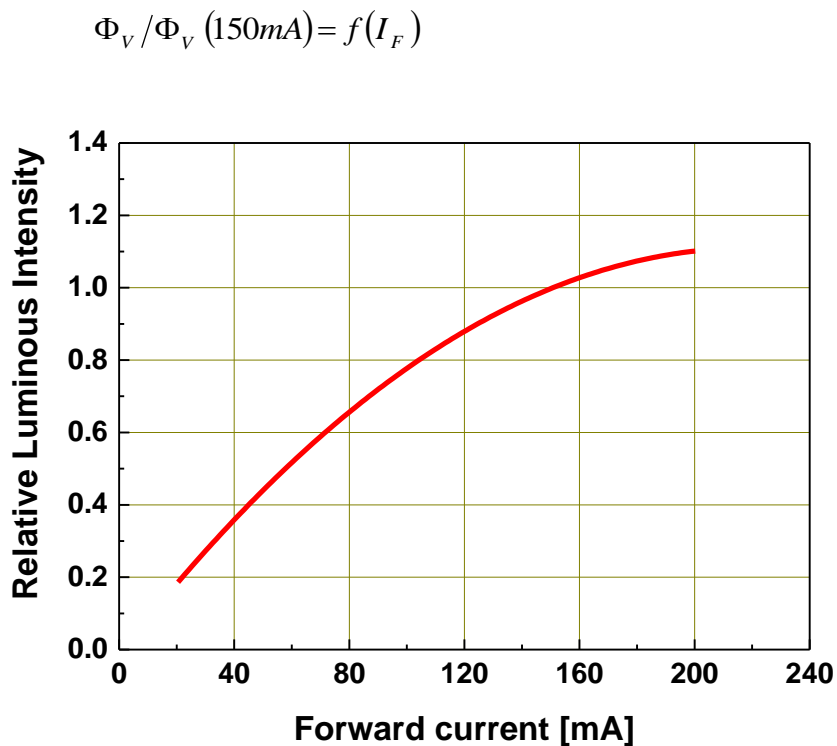

Dominant Wavelength vs. Forward Current @ $T_s = 25^\circ\text{C}$

$$\lambda_d = f(I_F)$$

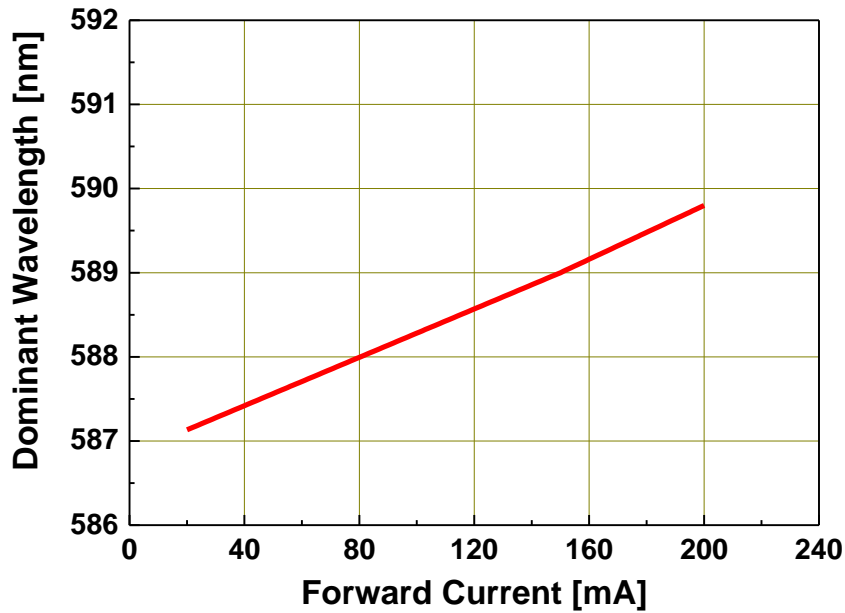

Relative Forward Voltage vs. Junction Temperature @ $I_F = 150\text{mA}$

$$\Delta V_F = V_F - V_F(25^\circ\text{C}) = f(T_j)$$

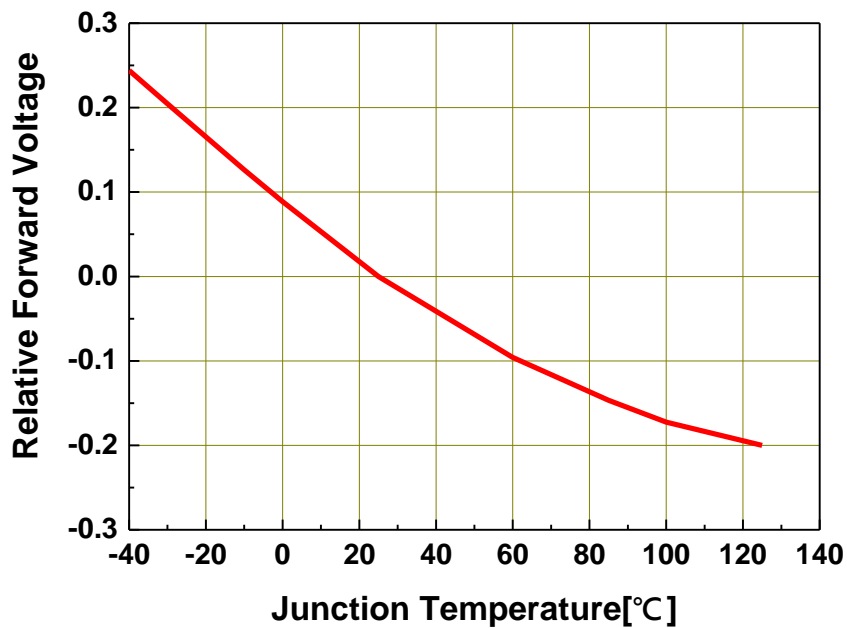

Relative Luminous Intensity vs. Junction Temperature

@ I_F=150mA

$$\Phi_v / \Phi_v(25^\circ C) = f(T_j)$$

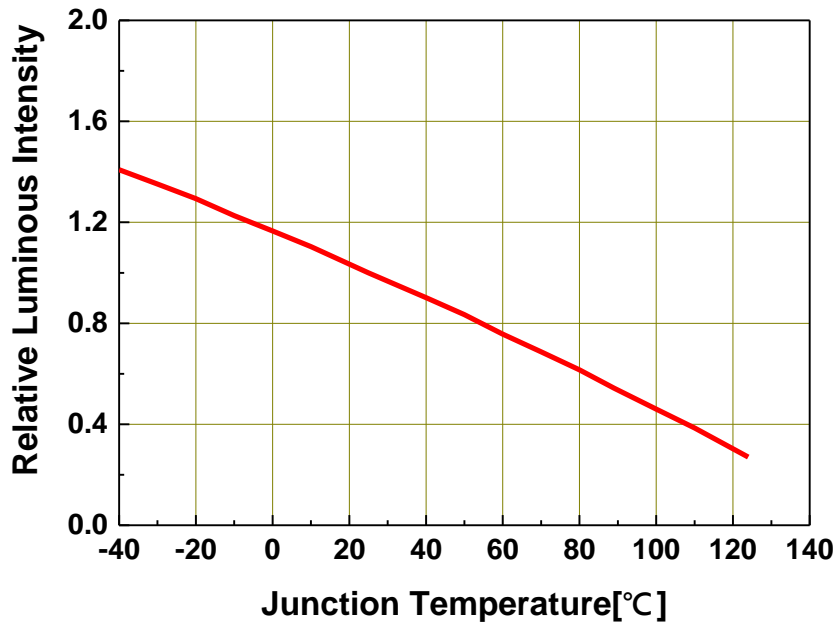

Relative Wavelength vs. Junction Temperature

@ I_F=150mA

$$\Delta\lambda_d = \lambda_d - \lambda_d(25^\circ C) = f(T_j)$$

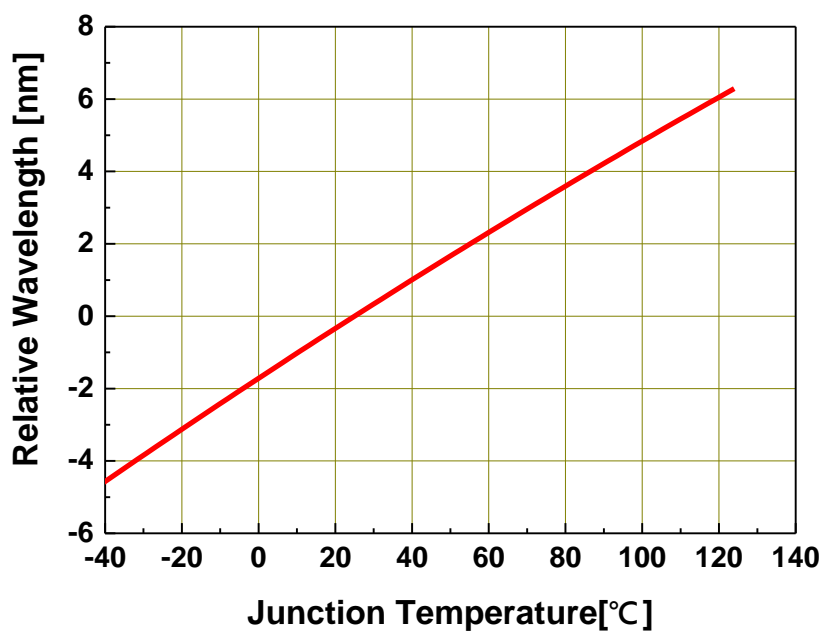

Forward Current Derating Curve

$$I_F = f(T_S)$$

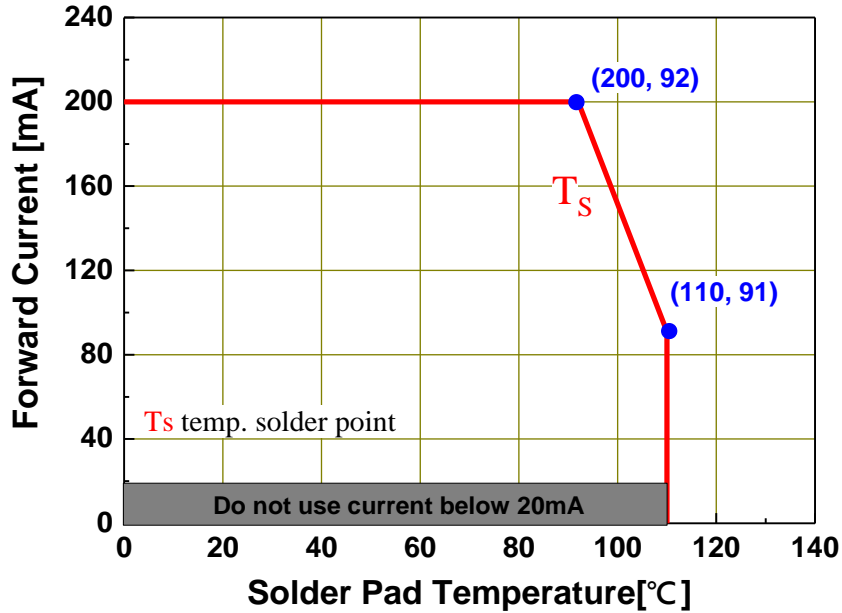

Permissible Pulse Handling Capability

D=Duty cycle, $T_s = 25^\circ\text{C}$

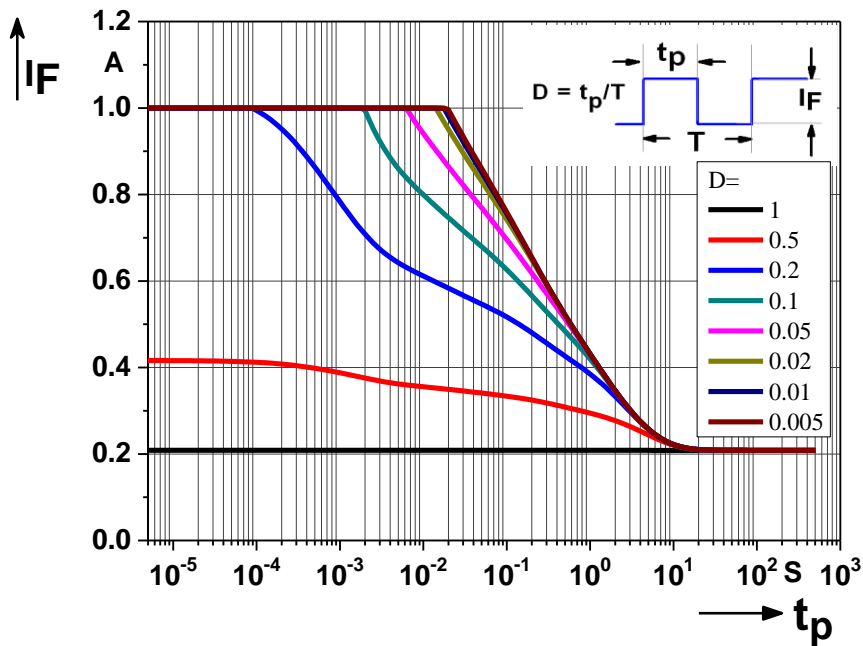

4. Binning Information

Luminous Intensity Bins

Group Bin	Minimum Luminous Intensity (mcd)	Maximum Luminous Intensity (mcd)
L1	11.2	14
L2	14	18
M1	18	22.4
M2	22.4	28
N1	28	35.5
N2	35.5	45
P1	45	56
P2	56	71
Q1	71	90
Q2	90	112
R1	112	140
R2	140	180
S1	180	224
S2	224	280
T1	280	355
T2	355	450
U1	450	560
U2	560	710
V1	710	900
V2	900	1120
AA	1120	1400
AB	1400	1800
BA	1800	2240
BB	2240	2800
CA	2800	3550
CB	3550	4500
DA	4500	5600
DB	5600	7100
EA	7100	9000
EB	9000	11200
FA	11200	14000
FB	14000	18000
GA	18000	22400

Notes:

1. Luminous flux measurement tolerance: $\pm 8\%$.
2. Highlighted Black Box is possible output bins.

Dominant Wavelength Bins

Group Bin	Minimum Dominant Wavelength [nm]	Maximum Dominant Wavelength [nm]
5963	459	463
6367	463	467
6771	467	471
7175	471	475
1015	510	515
1520	515	520
2025	520	525
2530	525	530
3035	530	535
5861	558	561
6164	561	564
6467	564	567
6770	567	570
7073	570	573
7376	573	576
7679	576	579
7982	579	582
8285	582	585
8588	585	588
8891	588	591
9194	591	594
9497	594	597
9700	597	600
0003	600	603
0306	603	606
0609	606	609
0912	609	612
1215	612	615
1518	615	618
1821	618	621
2124	621	624
2427	624	627
2730	627	630
3033	630	633
3336	633	636
3639	636	639

Notes:

1. Dominant wavelength measurement tolerance: ± 1 nm

Forward Voltage Bins

Bin code	Min Forward Voltage [V]	Max Forward Voltage [V]
1012	1.00	1.25
1215	1.25	1.50
1517	1.50	1.75
1720	1.75	2.00
2022	2.00	2.25
2225	2.25	2.50
2527	2.50	2.75
2730	2.75	3.00
3032	3.00	3.25
3235	3.25	3.50
3537	3.50	3.75
3740	3.75	4.00
4042	4.00	4.25
4245	4.25	4.50
4547	4.50	4.75
4750	4.75	5.00
5052	5.00	5.25
5255	5.25	5.50
5557	5.50	5.75
5760	5.75	6.00
6062	6.00	6.25
6265	6.25	6.50
6567	6.50	6.75
6770	6.75	7.00

Notes:

1. Forward voltage measurement tolerance: $\pm 0.05V$.
2. Forward voltage bins are defined at $I_F = 150mA$ operation.

5. Part Number

A09K-UY1501H-AM

Part number is designated with below details.

A09K = Product family name.

UY = Color ^[1]

150 = Test current [mA]

1 = Lead Frame Type (0=Ag ; 1=Au ; 2=MLP)

H = Brightness Level (H=High ; M=Medium ; L=Low)

AM = Automotive application

Note

[1] Color :

Symbol	Description
C	Cool White
N	Neutral White
W	Warm White
PA	Phosphor Converted Amber
PR	Phosphor Converted Red
UB	Blue
IB	Ice Blue
SB	Sky Blue
UP	Purple
UG	Green
UY	Yellow
UYG	Brilliant Yellow Green
UPG	Pale Green
UA	Amber
UR	Red
SR	Super Red
RGB	RGB-Color
PYG	Phosphor Converted Yellow Green

6. Ordering Information

A09K- UY1501H-**ABCDEFGHIJKLM-NO-AM**

Part Number of the A09K	Order Code
A09K-UY1501H-AM	A09K-UY1501H-ABCDEFGHIJKLM-NO-AM

Order code contains information with below details :

ABCD = min/max wavelength or CCT

EFGH = min./max. luminous flux in [lm] or luminous intensity in [mcd]

JKLM = min./max. forward voltage

NO = internal code

AM = Automotive Application

7. Mechanical Dimension

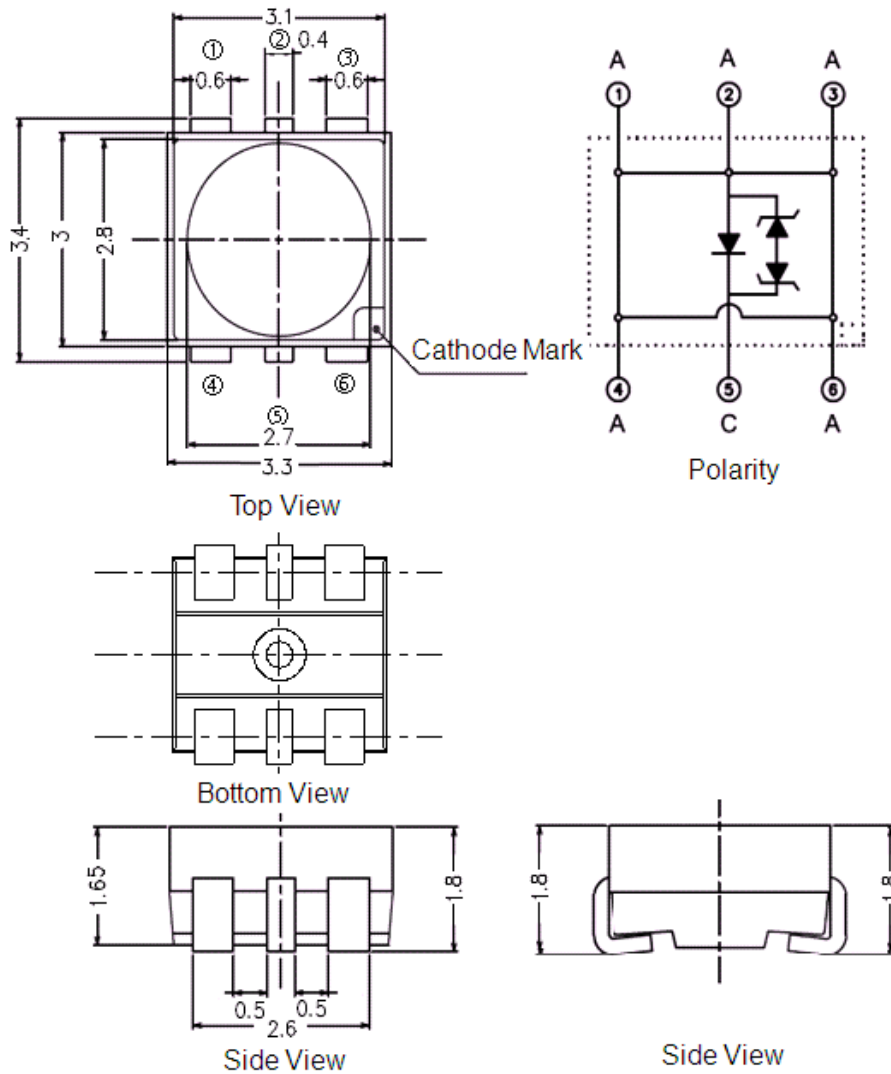

Notes:

1. Dimensions are in millimeters.
2. Tolerances unless mentioned are ± 0.1 mm.

8. Recommended Soldering Pad

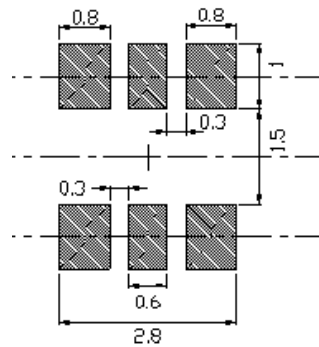

9. Reflow Soldering Profile

Soldering Condition (Reference: IPC/JEDEC J-STD-020D)

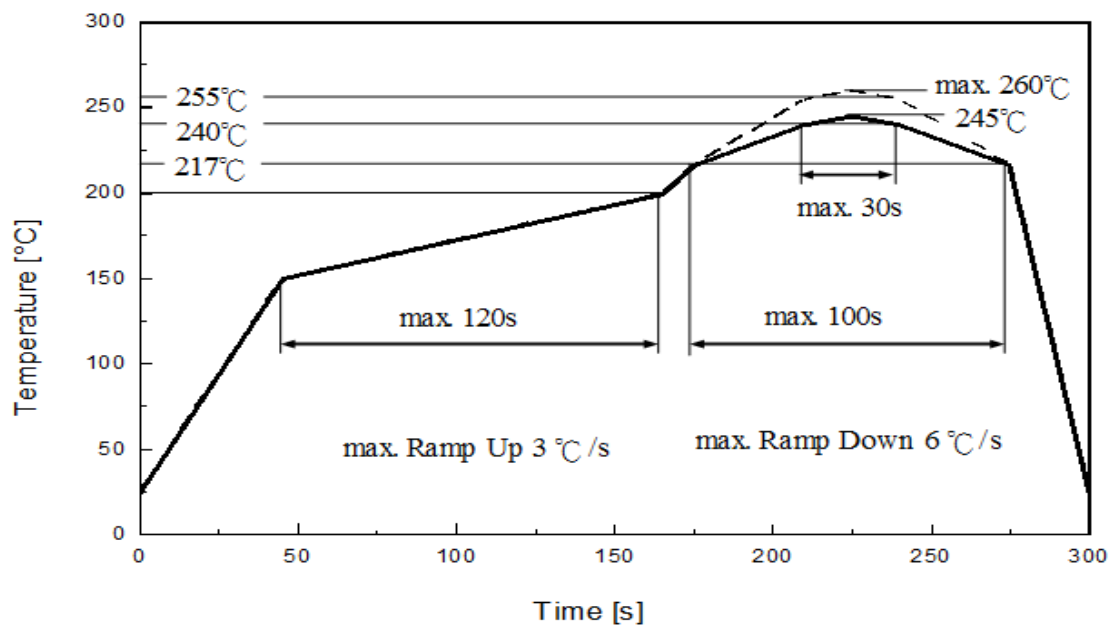

Profile Feature	Pb-Free Assembly	Unit
	Recommendation	
Ramp-up rate to preheat 25 °C to 150 °C	3	°C /sec
Time of soaking zone 150 °C to 200 °C	120	sec
Ramp-up rate to peak	3	°C /sec
Liquidus temperature	217	°C
Time above liquidus temperature	100	sec
Peak temperature (max.)	260	°C
Time within 5°C of the specified peak temperature	30	sec
Ramp-down Rate (max.)	6	°C /sec

10. Packaging Information

• Product Labeling



- CPN : Customer's Product Number
- P/N : Everlight Part Number
- QTY : Packing Quantity
- CAT : Luminous Flux (Brightness) Bin
- HUE : Color Bin
- REF : Forward Voltage Bin
- LOT No : Lot Number

• Packing: Loaded Quantity 1000 pcs Per Reel

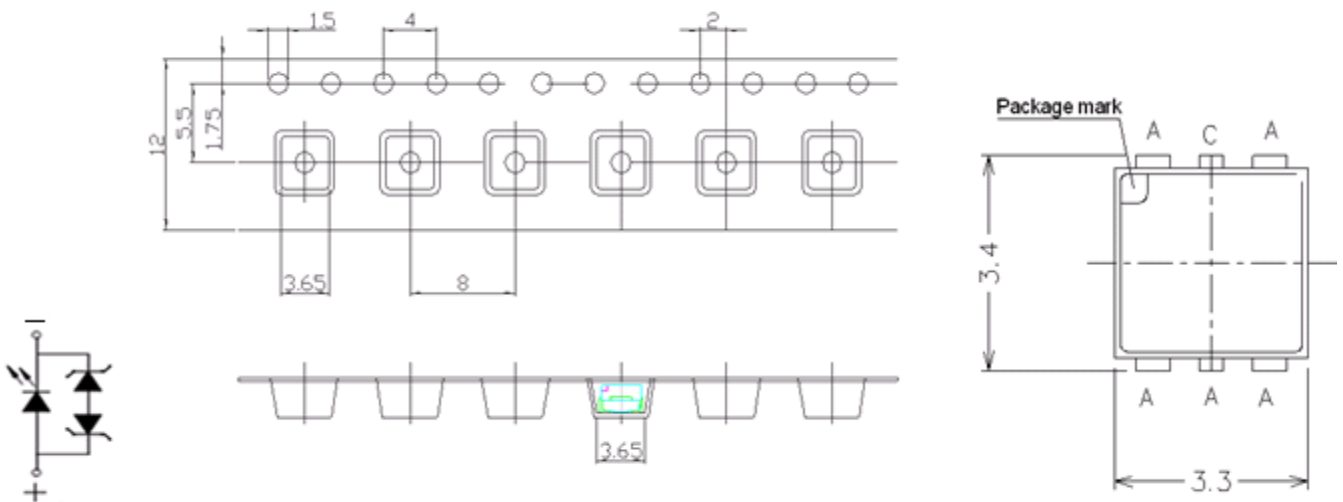

Notes:

1. Dimensions are in millimeters.

● **Reel Dimensions**

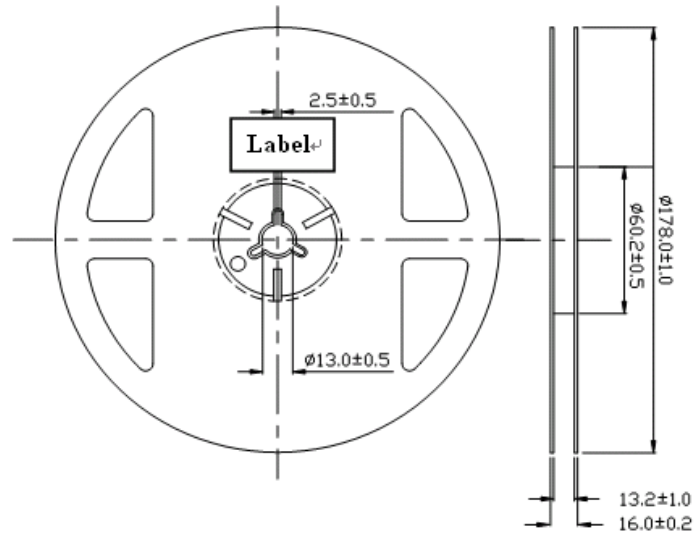

Notes:

1. Dimensions are in millimeters.

● **Moisture Resistant Packing Process**

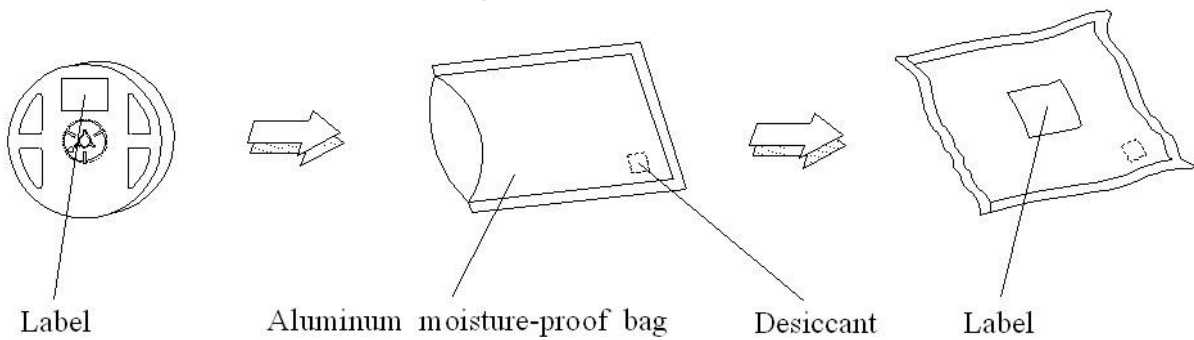

11. Precaution for Use

1. Over-current-proof

Customer must apply resistors for protection; otherwise slight voltage shift will cause big current change (burn out will happen).

2. Assemblies

Do not stack assemblies containing LEDs to prevent damage to the optical surface of LEDs. Forces applied to the optical surface may result in the surface being damaged.

3. Soldering Condition

3.1 When soldering, do not put stress on the LEDs during heating.

3.2 After soldering, do not warp the circuit board.

4. Soldering Iron

Each terminal is to go to the tip of soldering iron temperature less than 350°C for 3 seconds within once in less than the soldering iron capacity 25W. Leave two seconds and more intervals, and do soldering of each terminal. Be careful because the damage of the product is often started at the time of the hand solder.

5. Repairing

Repair should not be done after the LEDs have been soldered. When repairing is unavoidable, a double-head soldering iron should be used (as below figure). It should be confirmed beforehand whether the characteristics of the LEDs will or will not be damaged by repairing.

