

## Mini Top View LEDs 65-21-BFT-4DT2U1G7B-2T8



### Features

- P-LCC-2 package.
- Colored diffused resin.
- Wide viewing angle 120°.
- Inner reflector and white package.
- Brightness: 355 to 560 mcd at 5 mA
- Precondition: Bases on JEDEC J-STD 020D Level 3.
- Qualification according to AEC-Q101 rev C.
- Automotive reflow profile (IR reflow or wave soldering)

### Applications

- Automotive backlighting or indicator: Interior and exterior lighting, Dashboard, switch, reading lamp, audio and video equipments...etc.
- Backlight: LCD, switches, symbol, mobile phone and illuminated advertising.
- Display for indoor and outdoor application.
- Ideal for coupling into light guides.
- Substitution of traditional light.
- Optical indicator.
- General applications.

## Device Selection Guide

Chip Materials	Emitted Color	Resin Color
InGaN	White	Yellowish

## Absolute Maximum Ratings (Ta=25°C)

Parameter	Symbol	Rating	Unit
Forward Current	$I_F$	30	mA
Power Dissipation	$P_d$	99	mW
Junction Temperature	$T_j$	125	°C
Operating Temperature	$T_{opr}$	-40 ~ +100	°C
Storage Temperature	$T_{stg}$	-40 ~ +110	°C
Thermal Resistance	$R_{th\ J-A}$	500	K/W
	$R_{th\ J-S}$	300	K/W
ESD (Classification acc. AEC Q101)	$ESD_{HBM}$	2000	V
	$ESD_{MM}$	200	V
Soldering Temperature	$T_{sol}$	Reflow Soldering : 260 °C for 30 sec. Hand Soldering : 350 °C for 3 sec.	

### Electro-Optical Characteristics (Ta=25°C)

Parameter	Symbol	Min.	Typ.	Max.	Unit	Condition
Luminous Intensity	Iv	355	-----	560	mcd	I <sub>F</sub> =5mA
Viewing Angle	2θ <sub>1/2</sub>	-----	120	-----	deg	I <sub>F</sub> =5mA
Forward Voltage	V <sub>F</sub>	2.6	----	3.3	V	I <sub>F</sub> =5mA

Note:

1. Tolerance of Luminous Intensity: ±11%
2. Tolerance of Forward Voltage: ±0.1V

### Bin Range of Luminous Intensity

Bin Code	Min.	Max.	Unit	Condition
T2	355	450	mcd	I <sub>F</sub> =5mA
U1	450	560		

Note:

Tolerance of Luminous Intensity: ±11%

### Bin Range of Chromaticity Coordinates Specifications

Bin Code	CIE x	CIE y	Condition
4D	0.2775	0.2907	I <sub>F</sub> =5mA
	0.2775	0.2557	
	0.3025	0.2971	
	0.3025	0.3321	

Note:

Tolerance of Chromaticity Coordinates: ±0.01

### The C.I.E. 1931 Chromaticity Diagram

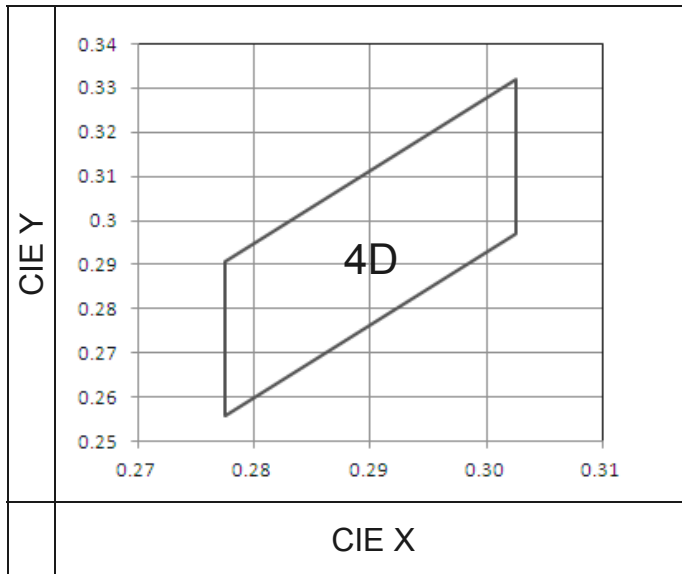

EVERLIGHT

## Typical Electro-Optical Characteristics Curves

### Typical Curve of Spectral Distribution

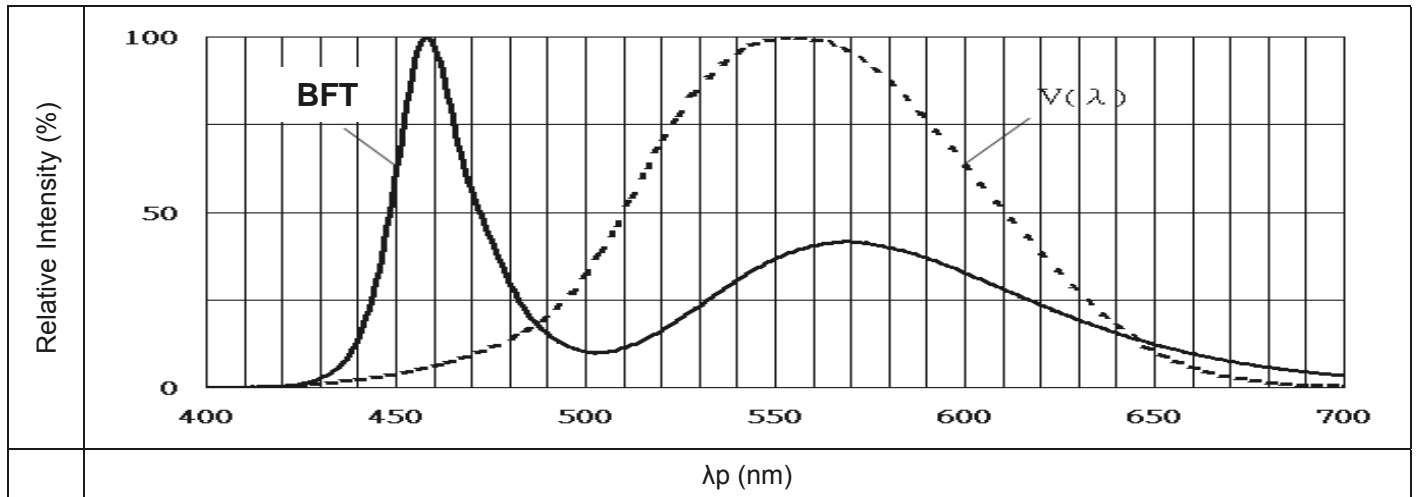

Note:  $V(\lambda)$ =Standard eye response curve;

### Diagram Characteristics of Radiation

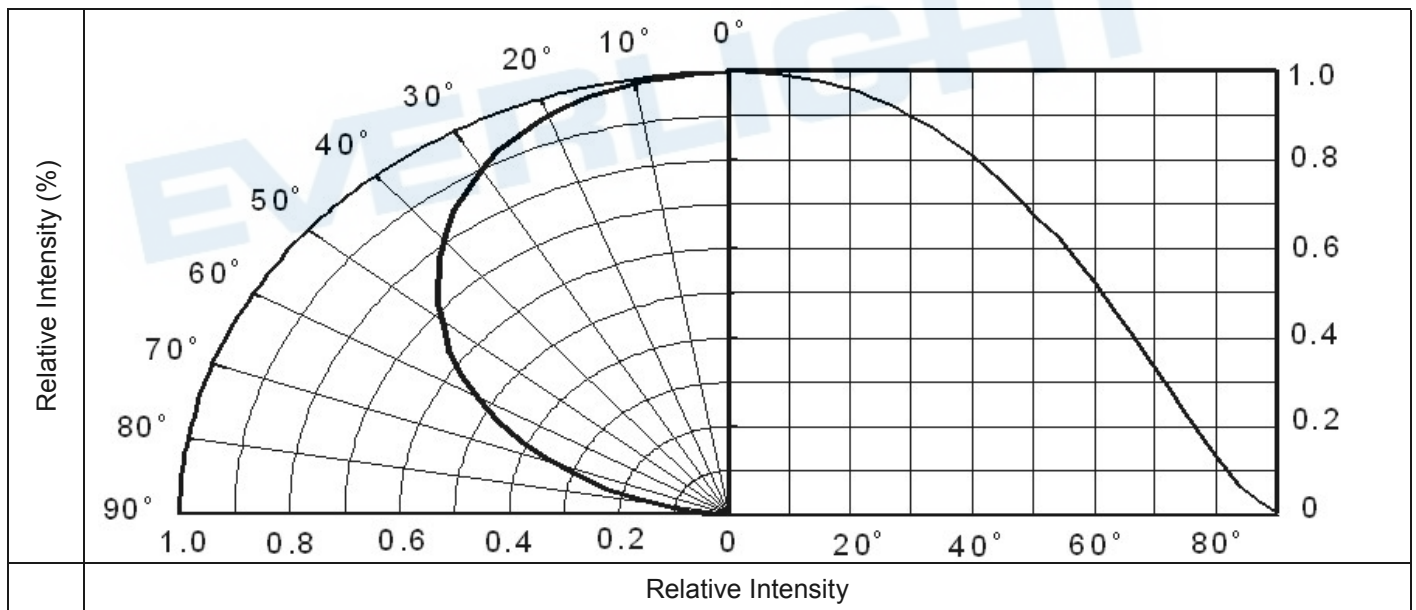

**Forward Current vs. Forward Voltage**  
 (Ta=25°C)

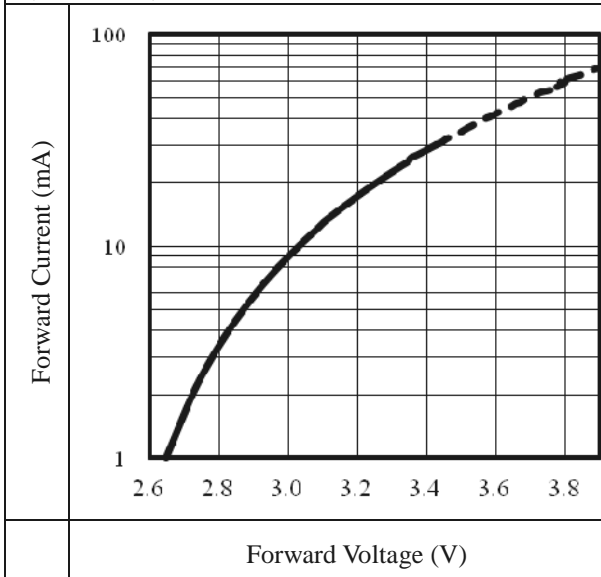

**Chromaticity Coordinates vs. Forward Current**  
 (Ta=25°C)

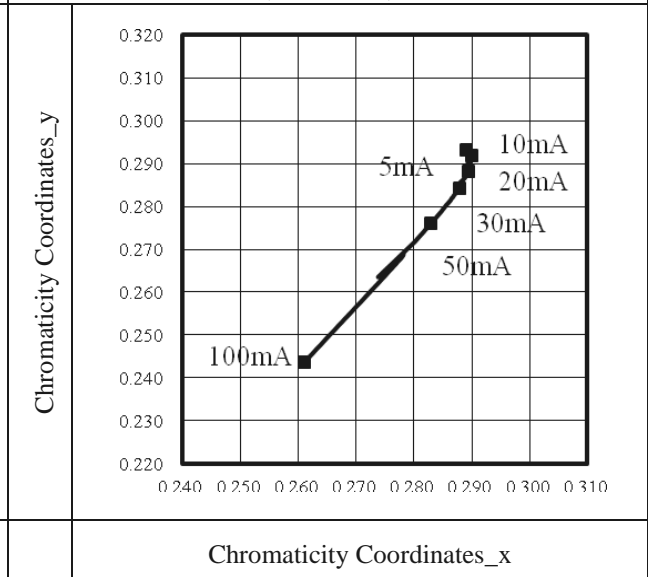

**Relative Luminous Intensity vs. Forward Current**  
 (Ta=25°C)

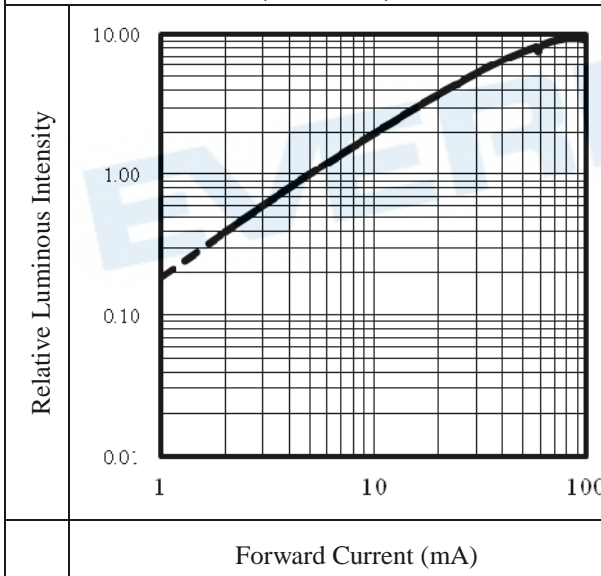

**Max. Permissible Forwarded Current**  
 (Ta=25°C)

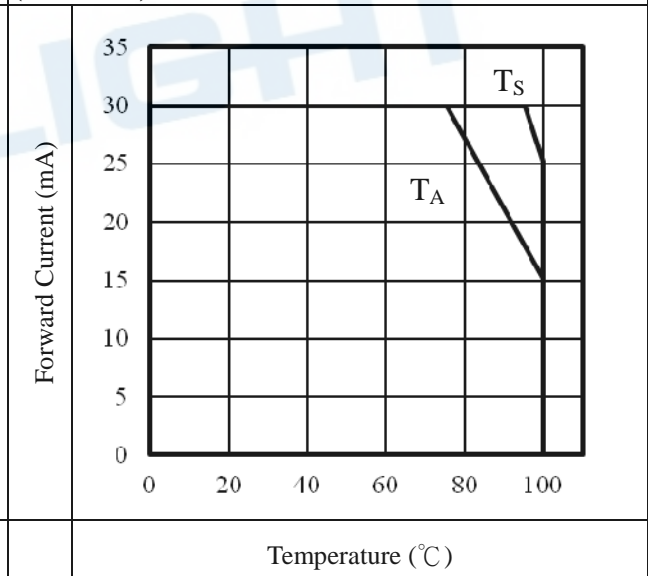

**Package Dimension**

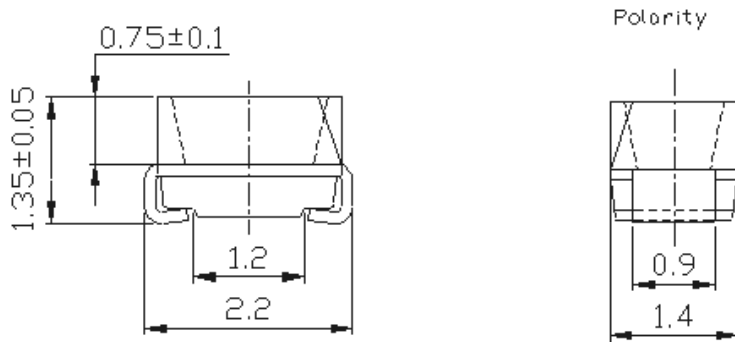
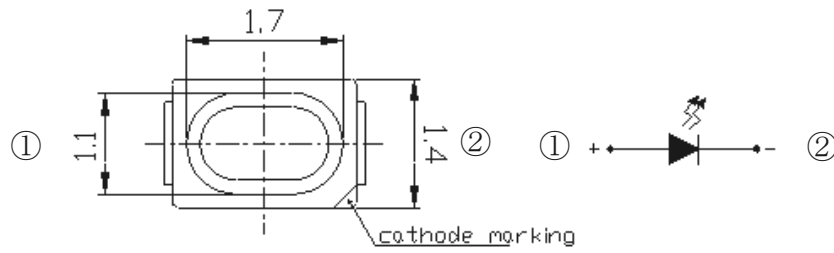

Note: Tolerances unless mentioned  $\pm 0.1$ mm. Unit = mm

EVERLIGHT

## Moisture Resistant Packing Materials

### Label Explanation



- CPN: Customer's Product Number
- P/N: Product Number
- QTY: Packing Quantity
- CAT: Luminous Intensity Rank
- HUE: Dom. Wavelength Rank
- REF: Forward Voltage Rank
- LOT No: Lot Number

### Reel Dimensions

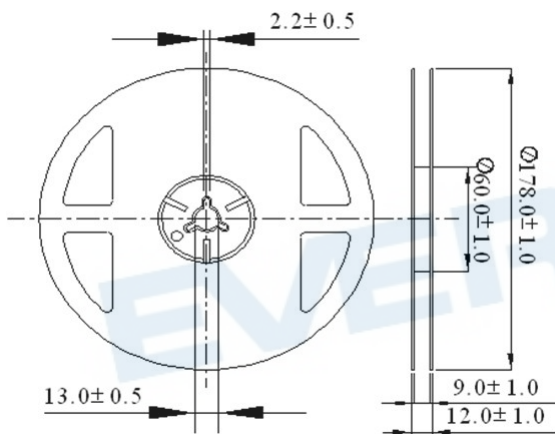

### Carrier Tape Dimensions: Loaded Quantity 2000 pcs Per Reel

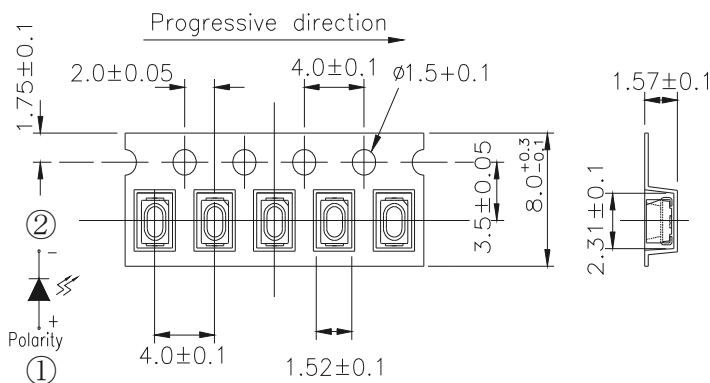

Note: Tolerances unless mentioned  $\pm 0.1$ mm. Unit = mm



### Moisture Resistant Packing Process

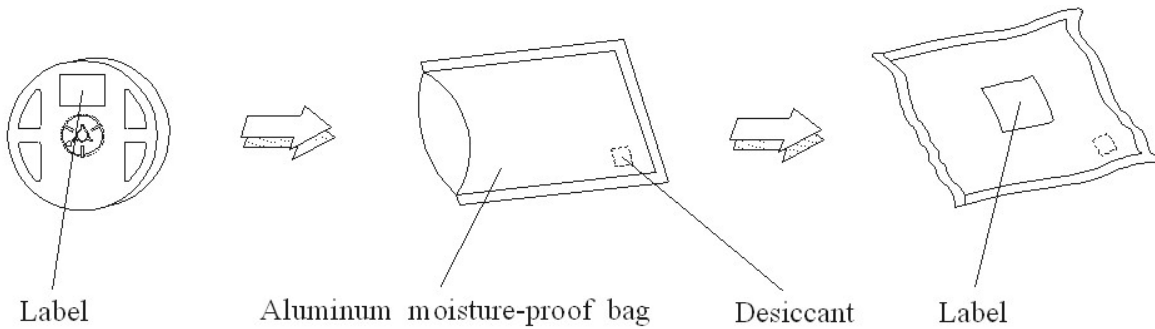

Note: Tolerances unless mentioned  $\pm 0.1\text{mm}$ . Unit = mm

### Precautions for Use

#### 1. Soldering Condition

##### 1.1 (A) Maximum Body Case Temperature Profile for evaluation of Reflow Profile

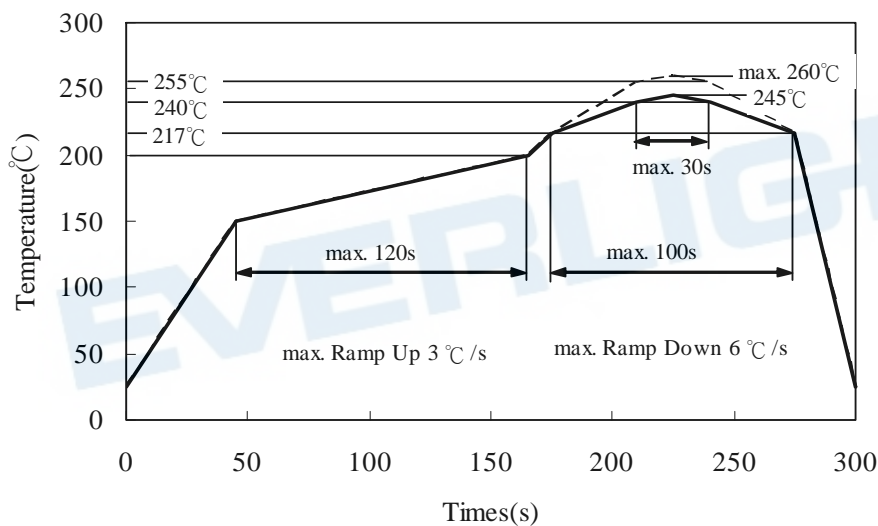

##### 1.2 (B) Recommend soldering pad

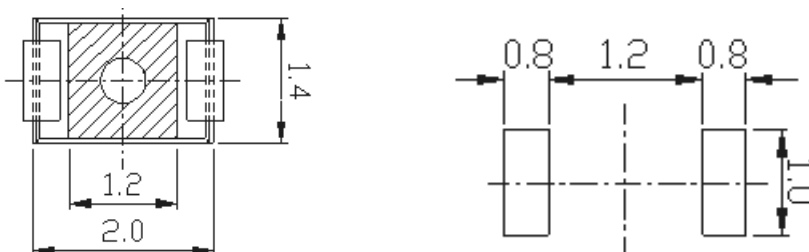

Note: Tolerances unless mentioned  $\pm 0.1\text{mm}$ . Unit = mm

### 2. Current limiting

A resistor should be used to limit current spikes that can be caused by voltage fluctuations. Otherwise damage could occur.

**3. Storage**

- 3.1 Moisture proof bag should only be opened immediately prior to usage.
- 3.2 Environment should be less than 30°C and 60% RH when moisture proof bag is opened.
- 3.3 After opening the package MSL Conditions stated on page 1 of this spec should not be exceeded.
- 3.4 If the moisture sensitivity card indicates higher than acceptable moisture, the component should be baked at min. 60deg +/-5deg for 24 hours.

**4. Iron Soldering**

Hand soldering is not recommended for regular production. These guidelines are for rework only. Soldering iron tip should contact each terminal no more than 3 sec at 350°C, using soldering iron with nominal power less than 25W. Allow min. 2 sec. between soldering intervals.

**5. Usage**

Do not exceed the values given in this specification.

**Application Restrictions**

High reliability applications such as military/aerospace, automotive safety/security systems, and medical equipment may require different product. If you have any concerns, please contact Everlight before using this product in your application. This specification guarantees the quality and performance of the product as an individual component. Do not use this product beyond the specification described in this document.

**Revision History:**

Rev.	Modified date	File modified contents
1	2013/08/08	New spec.(preliminary)
2	2013/09/03	Change to official edition