

2SB892 TRANSISTOR (PNP)

FEATURE

- Power Supplies, Relay Drivers, Lamp Drivers, and Automotive Wiring
- Low Saturation Voltage.
- Large Current Capacity and Wide ASO.

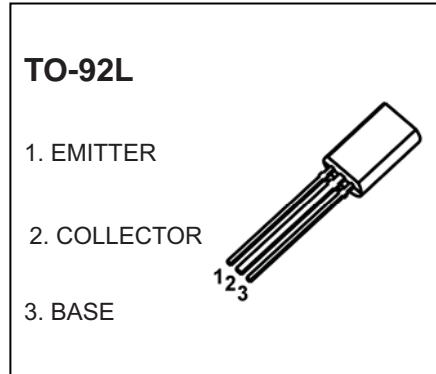

MARKING

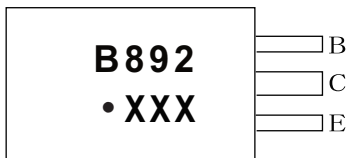

B892=Device code
 Solid dot = Green mdding compound device,
 if none, the normal device
 XXX=Code

Equivalent Circuit

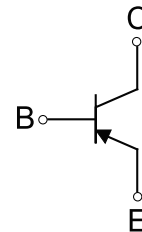

ORDERING INFORMATION

Part Number	Package	Packing Method	Pack Quantity
2SB892	TO-92L	Bulk	500pcs/Bag
2SB892-TA	TO-92L	Tape	2000pcs/Box

MAXIMUM RATINGS (T_a=25°C unless otherwise noted)

Symbol	Parameter	Value	Unit
V _{CB0}	Collector-Base Voltage	-60	V
V _{CE0}	Collector-Emitter Voltage	-50	V
V _{EBO}	Emitter-Base Voltage	-6	V
I _c	Collector Current -Continuous	-2	A
P _D	Collector Power Dissipation	750	mW
R _{θJA}	Thermal Resistance from Junction to Ambient	167	°C /W
T _J , T _{stg}	Operation Junction and Storage Temperature Range	-55~+150	°C

ELECTRICAL CHARACTERISTICS

$T_a=25^\circ\text{C}$ unless otherwise specified

Parameter	Symbol	Test conditions	Min	Max	Unit
Collector-base breakdown voltage	$V(\text{BR})_{\text{CBO}}$	$I_C = -100\mu\text{A}$, $I_E = 0$	-60		V
Collector-emitter breakdown voltage	$V(\text{BR})_{\text{CEO}}$	$I_C = -1\text{mA}$, $I_B = 0$	-50		V
Emitter-base breakdown voltage	$V(\text{BR})_{\text{EBO}}$	$I_E = -100\mu\text{A}$, $I_C = 0$	-6		V
Collector cut-off current	I_{CBO}	$V_{\text{CB}} = -50\text{V}$, $I_E = 0$		-0.1	μA
Emitter cut-off current	I_{EBO}	$V_{\text{EB}} = -4\text{V}$, $I_C = 0$		-0.1	μA
DC current gain	$h_{\text{FE}(1)}$	$V_{\text{CE}} = -2\text{V}$, $I_C = -100\text{mA}$	100	560	
	$h_{\text{FE}(2)}$	$V_{\text{CE}} = -2\text{V}$, $I_C = -1.5\text{A}$	40		
Collector-emitter saturation voltage	$V_{\text{CE(sat)}}$	$I_C = -1\text{A}$, $I_B = -50\text{mA}$		-0.4	V
Base-emitter saturation voltage	$V_{\text{BE(sat)}}$	$I_C = -1\text{A}$, $I_B = -50\text{mA}$		-1.2	V
Transition frequency	f_T	$V_{\text{CE}} = -10\text{V}$, $I_C = -50\text{mA}$	150		MHz

CLASSIFICATION OF $h_{\text{FE}(1)}$

Rank	R	S	T	U
Range	100-200	140-280	200-400	280-560

Typical Characteristics

Static Characteristic

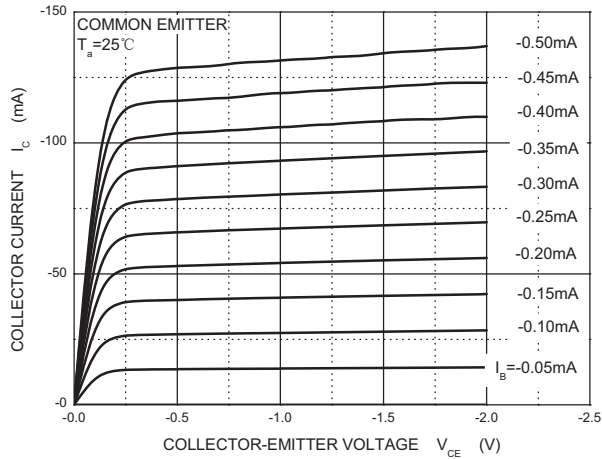

h_{FE} — I_C

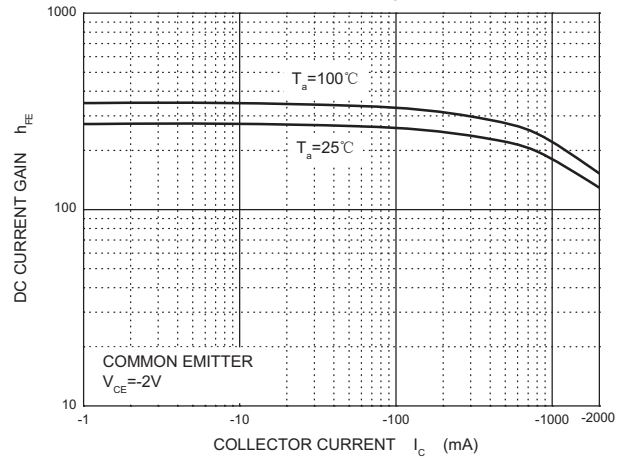

V_{CEsat} — I_C

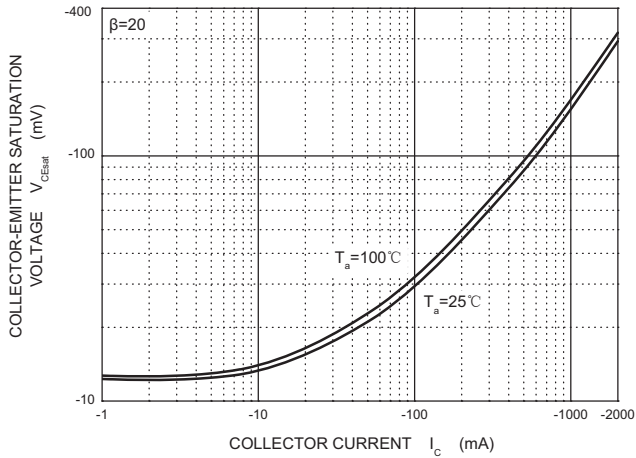

V_{BEsat} — I_C

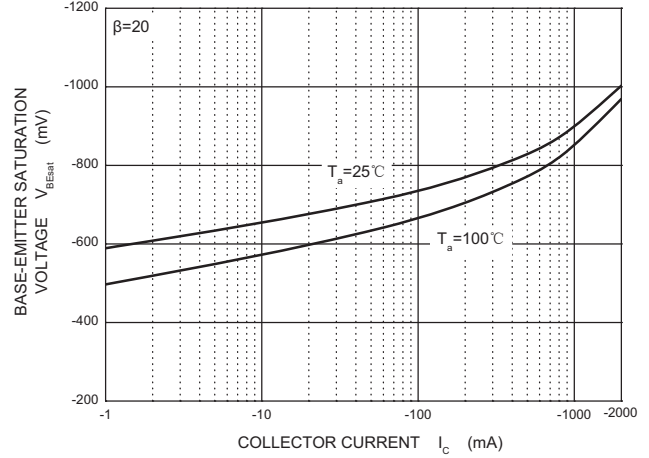

I_C — V_{BE}

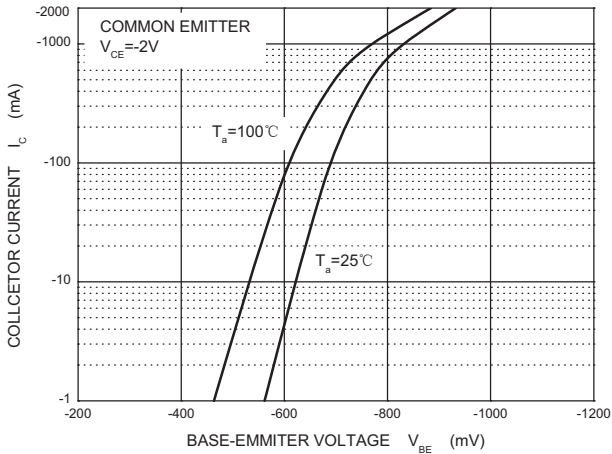

C_{ob}/C_{ib} — V_{CB}/V_{EB}

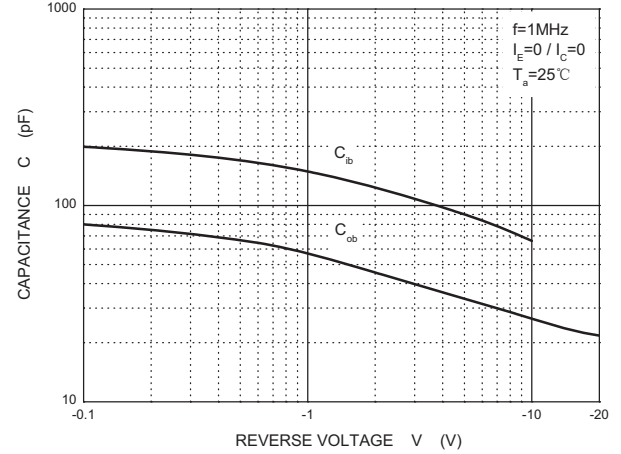

f_T — I_C

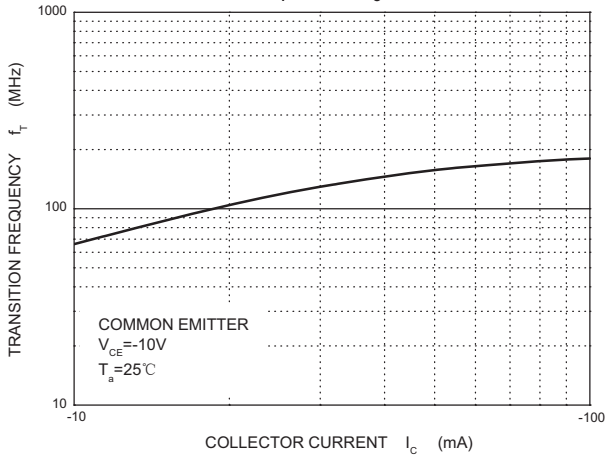

P_C — T_a

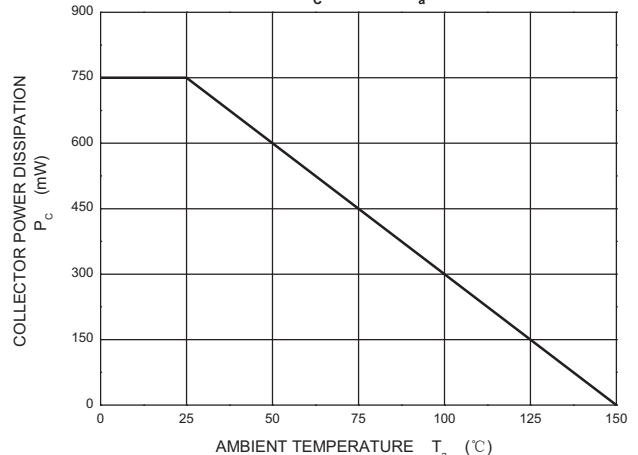

TO-92L Package Outline Dimensions

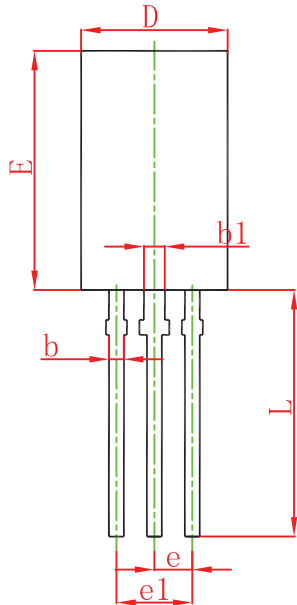
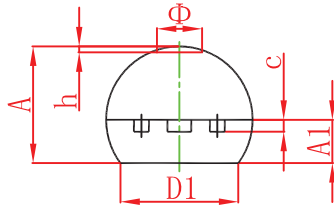

Symbol	Dimensions In Millimeters		Dimensions In Inches	
	Min.	Max.	Min.	Max.
A	3.750	4.050	0.148	0.159
A1	1.280	1.580	0.050	0.062
b	0.380	0.550	0.015	0.022
b1	0.620	0.780	0.024	0.031
c	0.350	0.450	0.014	0.018
D	4.750	5.050	0.187	0.199
D1	4.000		0.157	
E	7.850	8.150	0.309	0.321
e	1.270 TYP.		0.050 TYP.	
e1	2.440	2.640	0.096	0.104
L	13.800	14.200	0.543	0.559
Φ		1.600		0.063
h	0.000	0.300	0.000	0.012

TO-92L Suggested Pad Layout

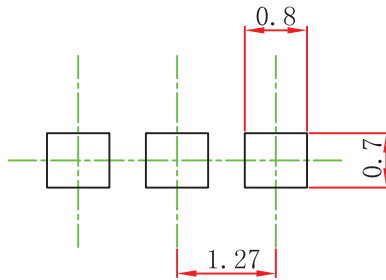

Note:

1. Controlling dimension: in millimeters.
2. General tolerance: ± 0.05 mm.
3. The pad layout is for reference purposes only.

NOTICE

JSCJ reserves the right to make modifications, enhancements, improvements, corrections or other changes without further notice to any product herein. JSCJ does not assume any liability arising out of the application or use of any product described herein.

TO-92L PACKAGE TAPING DIMENSION

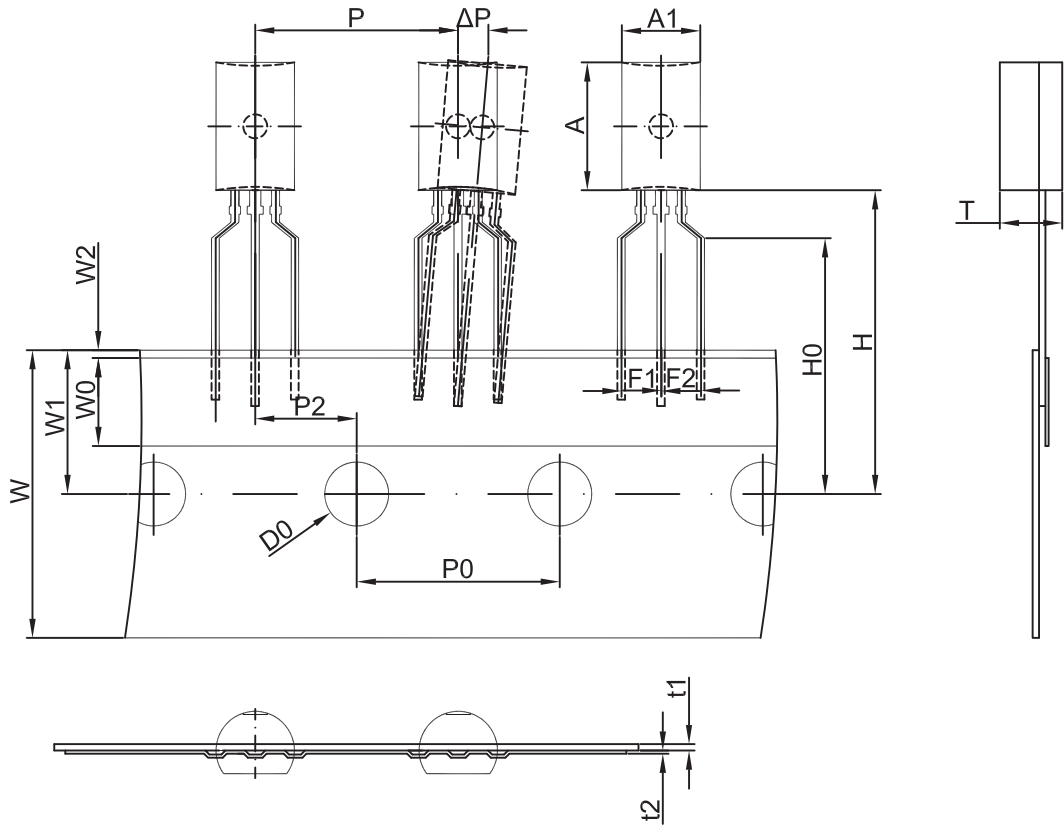

Dimensions are in millimeter

A1	A	T	P	P0	P2	F1	F2	W
4.9	8.0	3.9	12.7	12.7	6.35	2.5	2.5	18.0
W0	W1	W2	H	H0	D0	t1	t2	ΔP
6.0	9.0	1.0	19.0	16.0	4.0	0.4	0.2	0

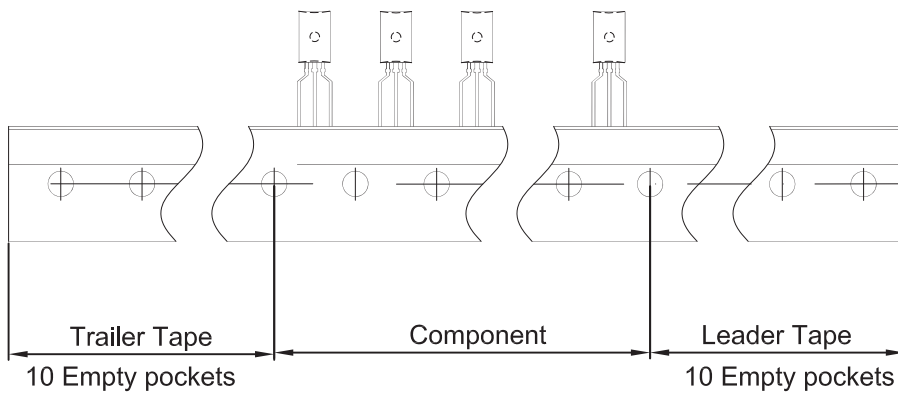

Package	Box	Box Size(mm)	Carton	Carton Size(mm)
TO-92L	2000 pcs	333×203×42	20,000 pcs	493×400×264