

SOT-363 Plastic-Encapsulate Transistors

UMF5N DUAL TRANSISTOR (PNP+NPN)

FEATURES

- 2SA2018 and DTC144E are housed independently in a package.
- Mounting possible with SOT-363 automatic mounting machines.
- Transistor elements are independent, eliminating interference.
- Mounting cost and area be cut in half.

Marking: F5

Tr1 Absolute maximum ratings (Ta=25°C)

Symbol	Parameter	Value	Units
V _{CB0}	Collector-Base Voltage	-15	V
V _{CEO}	Collector-Emitter Voltage	-12	V
V _{EBO}	Emitter-Base Voltage	-6	V
I _c	Collector Current	-500	mA
P _c	Collector Power Dissipation	150	mW
T _J , T _{stg}	Operation Junction and Storage Temperature Range	-55~+150	°C

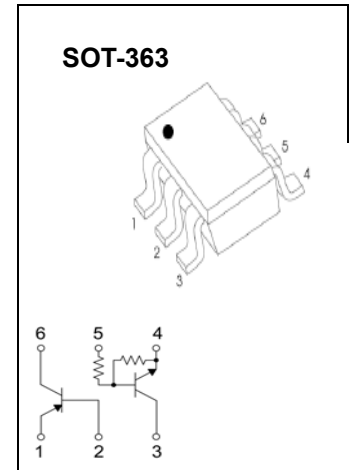

ELECTRICAL CHARACTERISTICS (Ta=25°C unless otherwise specified)

Parameter	Symbol	Test conditions	Min	Typ	Max	Unit
Collector-base breakdown voltage	V _{(BR)CBO}	I _C =-10μA, I _E =0	-15			V
Collector-emitter breakdown voltage	V _{(BR)CEO}	I _C =-1mA, I _B =0	-12			V
Emitter-base breakdown voltage	V _{(BR)EBO}	I _E =-10μA, I _C =0	-6			V
Collector cut-off current	I _{CBO}	V _{CB} =-15V, I _E =0			-0.1	μA
Emitter cut-off current	I _{EBO}	V _{EB} =-6V, I _C =0			-0.1	μA
DC current gain	h _{FE}	V _{CE} =-2V, I _C =-10mA	270		680	
Collector-emitter saturation voltage	V _{CE(sat)}	I _C =-200mA, I _B =-10mA			-0.25	V
Transition frequency	f _T	V _{CE} =-2V, I _E =-10mA, f=100MHz		260		MHz
Collector output capacitance	C _{ob}	V _{CB} =-10V, I _E =0, f=1MHz		6.5		pF

Tr2 Absolute maximum ratings(Ta=25°C)

Parameter	Symbol	Limits	Unit
Supply voltage	V_{CC}	50	V
Input voltage	V_{IN}	-10~+40	V
Output current	I_O	30	mA
	$I_{C(MAX)}$	100	
Power dissipation	P_d	150	mW
Junction temperature	T_j	150	°C
Storage temperature	T_{stg}	-55~150	°C

Electrical characteristics (Ta=25°C)

Parameter	Symbol	Min.	Typ	Max.	Unit	Conditions
Input voltage	$V_{I(off)}$	0.5			V	$V_{CC}=5V, I_O=100\mu A$
	$V_{I(on)}$			3.0		$V_O=0.3V, I_O=2mA$
Output voltage	$V_{O(on)}$		0.1	0.3	V	$I_O/I_I=10mA/0.5mA$
Input current	I_I			0.18	mA	$V_I=5V$
Output current	$I_{O(off)}$			0.5	μA	$V_{CC}=50V, V_I=0$
DC current gain	G_1	68				$V_O=5V, I_O=5mA$
Input resistance	R_1	32.9	47	61.1	K Ω	-
Resistance ratio	R_2/R_1	0.8	1	1.2		-
Transition frequency	f_T		250		MHz	$V_{CE}=10V, I_E=-5mA, f=100MHz$

SOT-363 Package Outline Dimensions

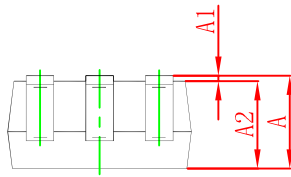
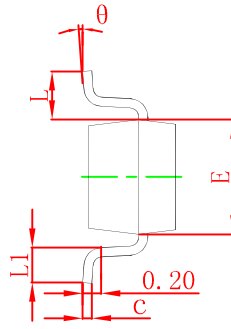
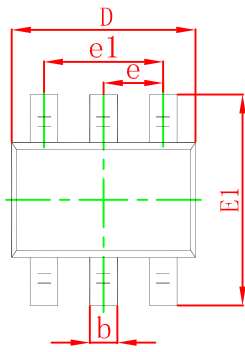

Symbol	Dimensions In Millimeters		Dimensions In Inches	
	Min	Max	Min	Max
A	0.900	1.100	0.035	0.043
A1	0.000	0.100	0.000	0.004
A2	0.900	1.000	0.035	0.039
b	0.150	0.350	0.006	0.014
c	0.100	0.150	0.004	0.006
D	2.000	2.200	0.079	0.087
E	1.150	1.350	0.045	0.053
E1	2.150	2.400	0.085	0.094
e	0.650 TYP		0.026 TYP	
e1	1.200	1.400	0.047	0.055
L	0.525 REF		0.021 REF	
L1	0.260	0.460	0.010	0.018
theta	0°	8°	0°	8°

SOT-363 Suggested Pad Layout

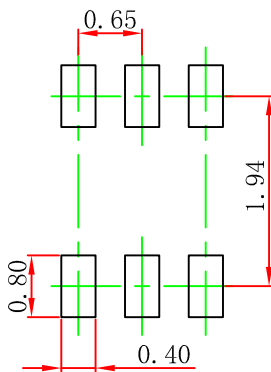

Note:

1. Controlling dimension: in millimeters.
2. General tolerance: $\pm 0.05\text{mm}$.
3. The pad layout is for reference purposes only.

NOTICE

JSCJ reserves the right to make modifications, enhancements, improvements, corrections or other changes without further notice to any product herein. JSCJ does not assume any liability arising out of the application or use of any product described herein.

SOT-363 Tape and Reel

SOT-363 Embossed Carrier Tape

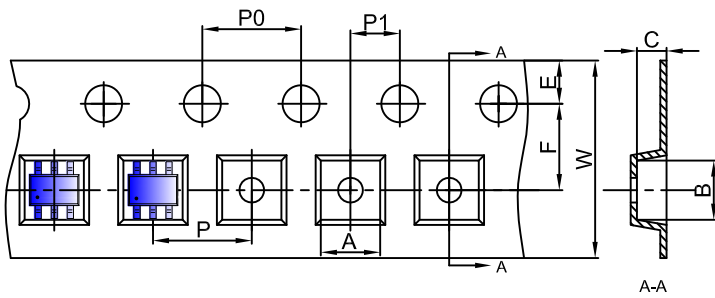

Packaging Description:

SOT-363 parts are shipped in tape. The carrier tape is made from a dissipative (carbon filled) polycarbonate resin. The cover tape is a multilayer film (Heat Activated Adhesive in nature) primarily composed of polyester film, adhesive layer, sealant, and anti-static sprayed agent. These reeled parts in standard option are shipped with 3,000 units per 7" or 17.8cm diameter reel. The reels are clear in color and is made of polystyrene plastic (anti-static coated).

Dimensions are in millimeter										
Pkg type	A	B	C	d	E	F	P0	P	P1	W
SOT-363	2.25	2.55	1.20	Ø1.50	1.75	3.50	4.00	4.00	2.00	8.00

SOT-363 Tape Leader and Trailer

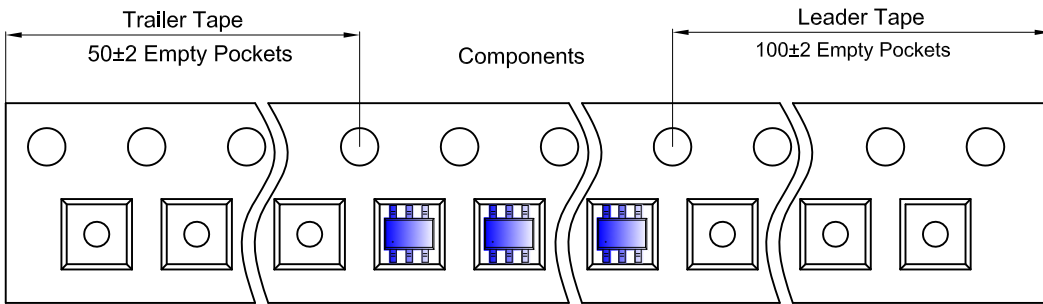

SOT-363 Reel

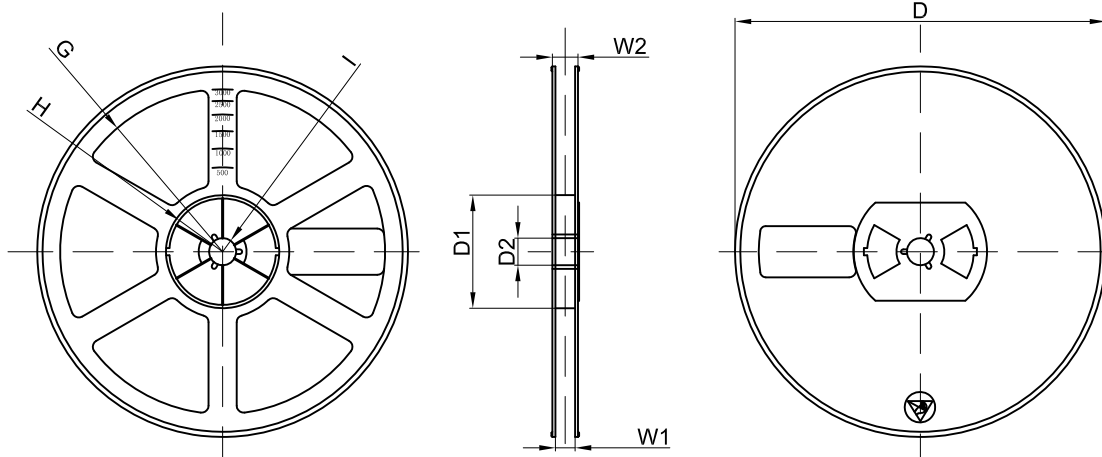

Dimensions are in millimeter								
Reel Option	D	D1	D2	G	H	I	W1	W2
7"Dia	Ø178.00	54.40	13.00	R78.00	R25.60	R6.50	9.50	12.30

REEL	Reel Size	Box	Box Size(mm)	Carton	Carton Size(mm)	G.W.(kg)
3000 pcs	7 inch	45,000 pcs	203×203×195	180,000 pcs	438×438×220	